

Part number

# TM 2314 PF

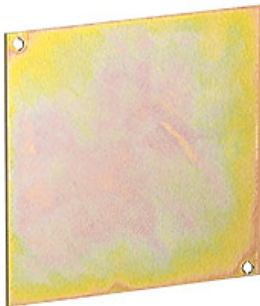

Fixing plate, TM series, for TM 2314 DB junction boxes



<b>Product description</b>		<b>General ordering information</b>	
<b>Product type</b>	Fixing plate	<b>EAN13 code</b>	8015747101455
<b>Series</b>	TM	<b>Packaging Information</b>	
<b>Specification</b>	For TM 2314 DB junction boxes	<b>Sub-packaging weight</b>	0,20 kg
<b>Further technical details</b>		<b>Sub-packaging description</b>	Plastic bag
<b>Weight</b>	200,00 g	<b>Sub-packaging quantity</b>	1 Pcs
<b>Operating temperature range (min, max)</b>	-40°C ... +125°C	<b>Sub-packaging EAN barcode</b>	8015747101554

Part number

# TM 2314 PF



Catalogue drawings

**TM 1125 PF**

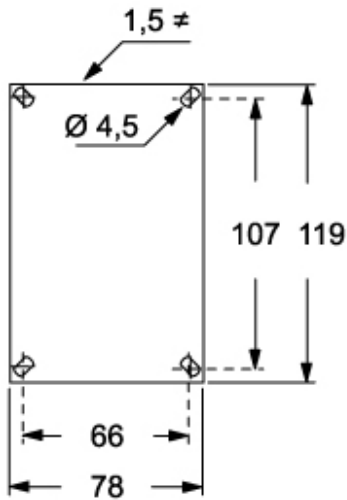

**TM xx14 PF**

