

Part number

TM 2314 DB



Box, TM series, with fixed cover, for 2 TM 1145 TB plates

Product description

Product type	Box
Series	TM
Specification	With fixed cover For 2 TM 1145 TB plates

Technical data

IP degree of protection	IP66 / IP67
Further technical details	
Weight	680,00 g
Operating temperature range (min, max)	-25°C ... +40°C
IK rating (impact degree of protection)	IK10

Material properties

Colour	RAL 7012 grey
RoHs conformity	Compliant with exemption 6(c): copper alloy containing up to 4% lead by weight
China RoHs - EFUP	50
REACH SVHC substances	Yes Lead
SCIP number	B0214dad-d2d9-4e91-a5b4-f4c9b4612083

General ordering information

EAN13 code	8015747101417
-------------------	---------------

Packaging Information

Packaging length	245,00 mm
Packaging height	165,00 mm
Packaging width	215,00 mm
Packaging weight	1,36 kg
Packaging volume	8,69 dm ³
Packaging description	Carton box
Packaging quantity	2 Pcs
Packaging EAN code	8015747101615
Sub-packaging weight	0,68 kg
Sub-packaging description	Plastic packaging
Sub-packaging quantity	1 Pcs
Sub-packaging EAN barcode	8015747101608

Part number

TM 2314 DB



Catalogue drawings

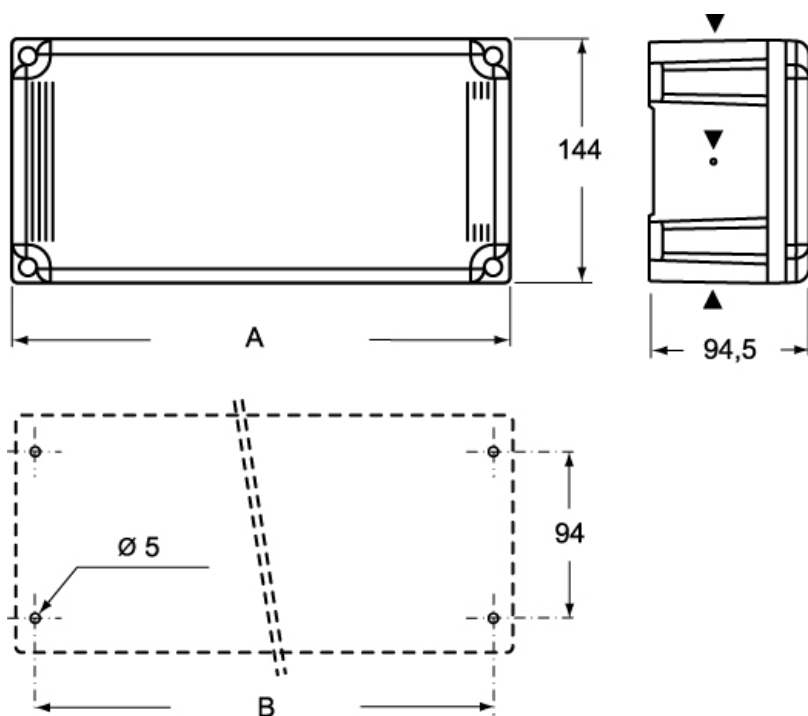

	A	B
TM 2314 DB	230	213
TM 2614 DB	260	243
TM 2914 DB	290	273