

Part number

# TM 1145 TB



Modular back plate for socket outlets set mounting, TM series

#### Product description

<b>Product type</b>	Modular back plate for socket outlets set mounting
<b>Series</b>	TM
<b>Size</b>	115 x 450 x 18 mm

#### Further technical details

<b>Weight</b>	360,00 g
<b>Operating temperature range (min, max)</b>	-25°C ... +40°C
<b>IK rating (impact degree of protection)</b>	IK10

#### Material properties

<b>Colour</b>	RAL 7012 grey
---------------	---------------

#### General ordering information

<b>EAN13 code</b>	8015747089357
-------------------	---------------

#### Packaging Information

<b>Packaging length</b>	255,00 mm
<b>Packaging height</b>	120,00 mm
<b>Packaging width</b>	470,00 mm
<b>Packaging weight</b>	3,60 kg
<b>Packaging volume</b>	14,38 dm <sup>3</sup>
<b>Packaging description</b>	Carton box
<b>Packaging quantity</b>	10 Pcs
<b>Packaging EAN code</b>	8015747089364
<b>Sub-packaging weight</b>	0,36 kg
<b>Sub-packaging description</b>	Plastic packaging
<b>Sub-packaging quantity</b>	1 Pcs
<b>Sub-packaging EAN barcode</b>	8015747089371

Part number

# TM 1145 TB



Catalogue drawings

**TM 1145 TB**

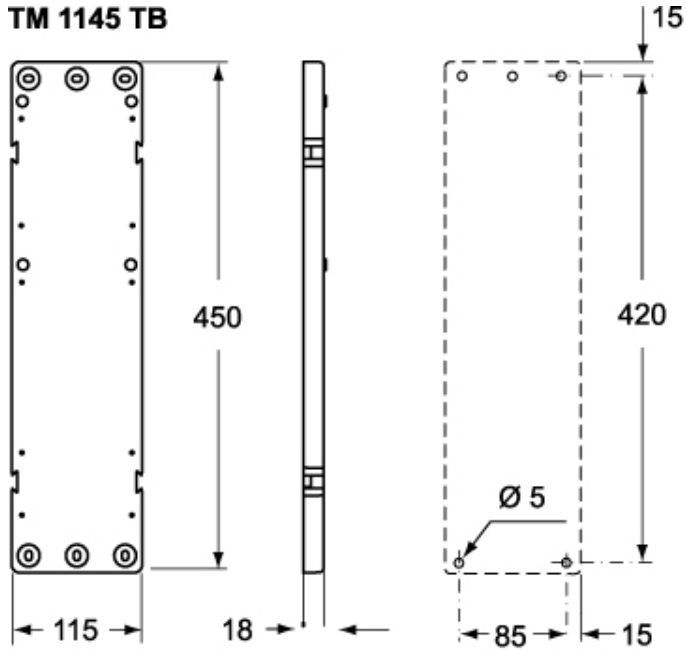

**TM 1456 TB**

