

Part number

PK 32115 PB5



Interlocked switched socket-outlet, PK series,
3 poles + N + PE, 11 h (red), 32 A, 250/440 ÷
265/460 V, E33 - DIII fuse carrier

Product description

Product type	Interlocked switched socket-outlet
Series	PK..PB5
N. of poles	3 poles + N + 
Clock position	11
Specification	E33 - DIII fuse carrier

Technical data

Current	32 A
Voltage	250/440V ÷ 265/460V
IP degree of protection	IP55

Further technical details

Operating temperature range (min, max)	-25°C ... +40°C
IK rating (impact degree of protection)	IK10

Material properties

Colour	RAL 7035 grey, RAL 3000 red
---------------	-----------------------------

Approvals / Standards

Reference standard	EN 60309-1, -2 e -4
---------------------------	---------------------

General ordering information

EAN13 code	8015747158848
-------------------	---------------

Part number

PK 32115 PB5



Catalogue drawings

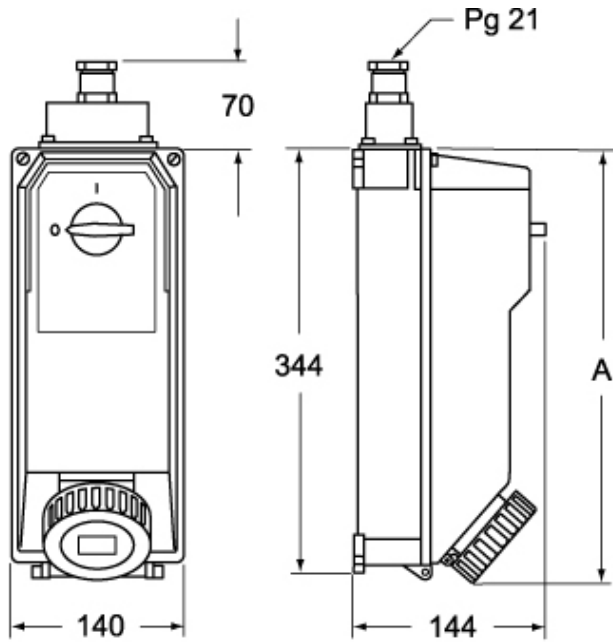

	A
2P+⊕	363
3P+⊕	370
3P+N+⊕	370