

Part number

# PEW 3254 PP



Wall-mounting socket outlet, PLUSO series, 3 poles + PE, 5 h (black), 32 A, 600 ÷ 690 V

#### Product description

<b>Product type</b>	Socket Wall-mounting
<b>Series</b>	PEW...PP, PLUSO
<b>N. of poles</b>	3 poles + 
<b>Clock position</b>	5

#### Technical data

<b>Current</b>	32 A
<b>Voltage</b>	600 ÷ 690 V
<b>IP degree of protection</b>	IP67

#### Further technical details

<b>Operating temperature range (min, max)</b>	-25°C ... +40°C
---	-----------------

#### Material properties

<b>Colour</b>	RAL 7035 grey, RAL 9005 black
---------------	-------------------------------

#### Approvals / Standards

<b>Reference standard</b>	EN 60309-1 and -2
---------------------------	-------------------

#### General ordering information

<b>EAN13 code</b>	8015747157889
-------------------	---------------

Part number

# PEW 3254 PP



Catalogue drawings

( 16 / 32A) PEW ... PP

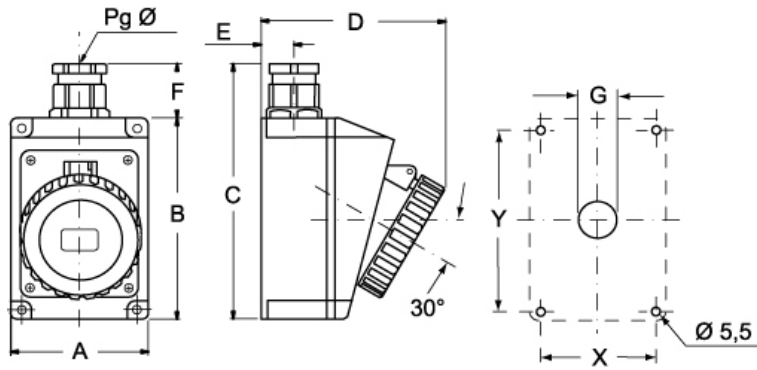

PEW ... PP	A	B	C	D	E	F	G	X	Y	Pg Ø
<b>16A</b> 2P+⊕	75	115	150	105	19	33	Ø22	65	105	16
3P+⊕	75	115	150	108	19	33	Ø22	65	105	16
3P+N+⊕	100	130	172	120	22	33	Ø22	85	115	21
<b>32A</b> 2P+⊕	100	130	172	120	22	42	Ø28	85	115	21
3P+⊕	100	130	172	120	22	42	Ø28	85	115	21
3P+N+⊕	100	130	172	120	22	42	Ø28	85	115	21