

Part number

PEW 1655 PP



Wall-mounting socket outlet, PLUSO series, 3 poles + N + PE, 5 h (black), 16 A, 347/600 ÷ 400/690 V

Product description

Product type	Socket Wall-mounting
Series	PEW...PP, PLUSO
N. of poles	3 poles + N + 
Clock position	5

Technical data

Current	16 A
Voltage	347/600 ÷ 400/690 V
IP degree of protection	IP67

Further technical details

Weight	435,00 g
Operating temperature range (min, max)	-25°C ... +40°C

Material properties

Colour	RAL 7035 grey, RAL 9005 black
RoHs conformity	Compliant with exemption 6(c): copper alloy containing up to 4% lead by weight
China RoHs - EFUP	50
REACH SVHC substances	Yes Lead
SCIP number	Ca7de37f-add8-4b77-9861-279c94903ade

Approvals / Standards

Reference standard	EN 60309-1 and -2
---------------------------	-------------------

General ordering information

EAN13 code	8015747072496
-------------------	---------------

Packaging Information

Packaging length	440,00 mm
Packaging height	180,00 mm
Packaging width	330,00 mm
Packaging weight	4,81 kg
Packaging volume	26,14 dm ³
Packaging description	Carton box
Packaging quantity	10 Pcs
Packaging EAN code	8015747072502

Part number

PEW 1655 PP



Catalogue drawings

(16 / 32A) PEW ... PP

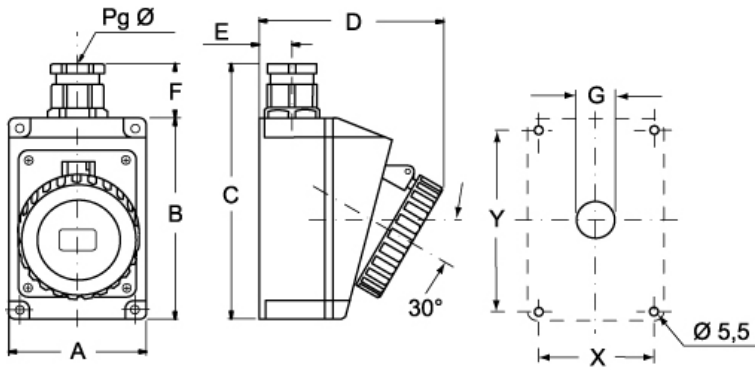

PEW ... PP	A	B	C	D	E	F	G	X	Y	Pg Ø
16A 2P+⊕	75	115	150	105	19	33	Ø22	65	105	16
3P+⊕	75	115	150	108	19	33	Ø22	65	105	16
3P+N+⊕	100	130	172	120	22	33	Ø22	85	115	21
32A 2P+⊕	100	130	172	120	22	42	Ø28	85	115	21
3P+⊕	100	130	172	120	22	42	Ø28	85	115	21
3P+N+⊕	100	130	172	120	22	42	Ø28	85	115	21