

Part number

PE 1693 PP



Wall-mounting socket outlet, PLUSO series, 2 poles + PE, 9 h (red), 16 A, 380 ÷ 415 V

Product description

Product type	Socket Wall-mounting
Series	PE...PP, PLUSO
N. of poles	2 poles + 
Clock position	9

Technical data

Current	16 A
Voltage	380 ÷ 415 V
IP degree of protection	IP44

Further technical details

Weight	189,00 g
Operating temperature range (min, max)	-25°C ... +40°C

Material properties

Colour	RAL 7035 grey, RAL 3000 red
RoHs conformity	Compliant with exemption 6(c): copper alloy containing up to 4% lead by weight
China RoHs - EFUP	50
REACH SVHC substances	Yes Lead
SCIP number	Ca7de37f-add8-4b77-9861-279c94903ade

Approvals / Standards

Reference standard	EN 60309-1 and -2
---------------------------	-------------------

General ordering information

EAN13 code	8015747065344
-------------------	---------------

Packaging Information

Packaging length	208,00 mm
Packaging height	140,00 mm
Packaging width	290,00 mm
Packaging weight	2,04 kg
Packaging volume	8,44 dm ³
Packaging description	Carton box
Packaging quantity	10 Pcs
Packaging EAN code	8015747065351

Part number

PE 1693 PP



Catalogue drawings

(16 / 32A) PE ... PP

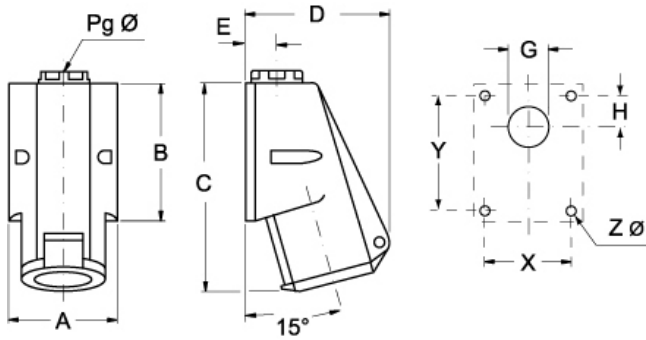

PE ... PP	A	B	C	D	E	G	H	X	Y	Pg Ø	Z Ø	
16A	2P+⊕	70	82	126	92	20	Ø22	16	53	65	16	4,5
	3P+⊕	70	82	126	92	20	Ø22	16	53	65	16	4,5
	3P+N+⊕	70	82	132	106	20	Ø22	16	53	65	16	4,5
32A	2P+⊕	86	104	159	110	24	Ø28	17	61	79	21	6,5
	3P+⊕	86	104	159	110	24	Ø28	17	61	79	21	6,5
	3P+N+⊕	86	104	159	110	24	Ø28	17	61	79	21	6,5