

Part number

# PE 1673 PIF



Flush-mounting socket outlet, PLUSO series, 2 poles + PE, 7 h (black), 16 A, 480 ÷ 500 V, inclined, with bigger flange

#### Product description

<b>Product type</b>	Socket Flush-mounting
<b>Series</b>	PE...PIF, PLUSO
<b>N. of poles</b>	2 poles + 
<b>Clock position</b>	7
<b>Specification</b>	Inclined, bigger flange

#### Technical data

<b>Current</b>	16 A
<b>Voltage</b>	480 ÷ 500 V
<b>IP degree of protection</b>	IP44

#### Further technical details

<b>Operating temperature range (min, max)</b>	-25°C ... +40°C
---	-----------------

#### Material properties

<b>Colour</b>	RAL 7035 grey, RAL 9005 black
---------------	-------------------------------

#### Approvals / Standards

<b>Reference standard</b>	EN 60309-1 and -2
---------------------------	-------------------

#### General ordering information

<b>EAN13 code</b>	8015747155045
-------------------	---------------

Part number

# PE 1673 PIF



Catalogue drawings

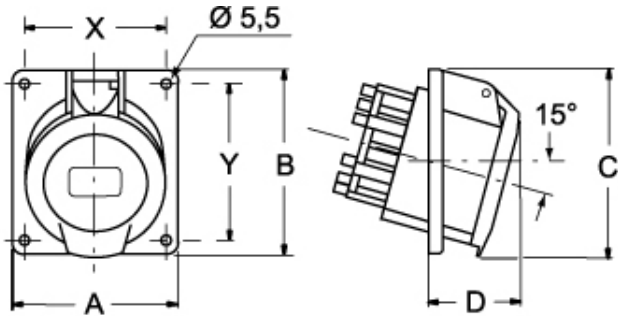

			A	B	C	D	X	Y
<b>PIF</b>	<b>16 A</b>	2P+⊕	92	100	--	52	77	85
		3P+⊕	92	100	--	53	77	85
<b>PI</b>	<b>16 A</b>	2P+⊕	64	82	--	38	52	60
		3P+⊕	64	82	--	42	52	60
		3P+N+⊕	92	100	--	43	77	60
<b>PI</b>	<b>32 A</b>	2P+⊕	92	100	--	40	77	85
		3P+⊕	92	100	--	40	77	85
		3P+N+⊕	92	102	--	43	77	85