

Part number

# PE 1645 PP



Wall-mounting socket outlet, PLUSO series, 3 poles + N + PE, 4 h (yellow), 16 A, 57/100 ÷ 75/130 V

#### Product description

<b>Product type</b>	Socket Wall-mounting
<b>Series</b>	PE...PP, PLUSO
<b>N. of poles</b>	3 poles + N + 
<b>Clock position</b>	4

#### Technical data

<b>Current</b>	16 A
<b>Voltage</b>	57/100 ÷ 75/130 V
<b>IP degree of protection</b>	IP44

#### Further technical details

<b>Weight</b>	233,00 g
<b>Operating temperature range (min, max)</b>	-25°C ... +40°C

#### Material properties

<b>Colour</b>	RAL 7035 grey, RAL 1021 yellow
<b>RoHs conformity</b>	Compliant with exemption 6(c): copper alloy containing up to 4% lead by weight
<b>China RoHs - EFUP</b>	50
<b>REACH SVHC substances</b>	Yes Lead
<b>SCIP number</b>	Ca7de37f-add8-4b77-9861-279c94903ade

#### Approvals / Standards

<b>Reference standard</b>	EN 60309-1 and -2
---------------------------	-------------------

#### General ordering information

<b>EAN13 code</b>	8015747064125
-------------------	---------------

#### Packaging Information

<b>Packaging length</b>	330,00 mm
<b>Packaging height</b>	175,00 mm
<b>Packaging width</b>	295,00 mm
<b>Packaging weight</b>	2,67 kg
<b>Packaging volume</b>	17,04 dm <sup>3</sup>
<b>Packaging description</b>	Carton box
<b>Packaging quantity</b>	10 Pcs
<b>Packaging EAN code</b>	8015747064132

Part number

# PE 1645 PP



Catalogue drawings

(16 / 32A) PE ... PP

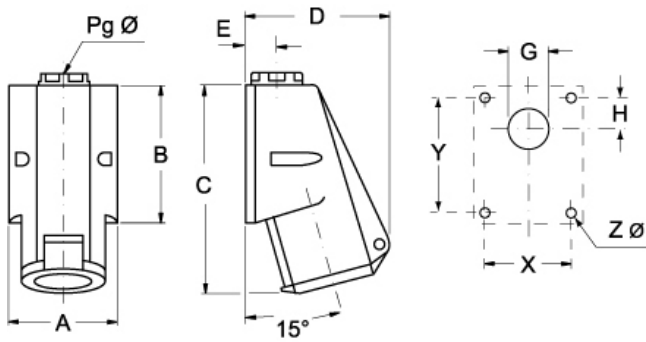

PE ... PP	A	B	C	D	E	G	H	X	Y	Pg Ø	Z Ø
<b>16A</b> 2P+⊕	70	82	126	92	20	Ø22	16	53	65	16	4,5
3P+⊕	70	82	126	92	20	Ø22	16	53	65	16	4,5
3P+N+⊕	70	82	132	106	20	Ø22	16	53	65	16	4,5
<b>32A</b> 2P+⊕	86	104	159	110	24	Ø28	17	61	79	21	6,5
3P+⊕	86	104	159	110	24	Ø28	17	61	79	21	6,5
3P+N+⊕	86	104	159	110	24	Ø28	17	61	79	21	6,5