

Part number

MXA 02 IAP25



Angled bulkhead mounting housing, MIXO TWO series, with 1 lever, M25 top cable entry, with 1 lever, 2 modules, with PE connection terminal and contact

Product description

Product type	Angled bulkhead mounting housing
Series	MIXO TWO
Closing type	With 1 lever
Size	2 modules
Cable entry	Top cable entry M25
Specification	With PE connection terminal and contact

Technical data

IP degree of protection IP65

Further technical details

Mating cycles	≥ 500
Weight	311,00 g
Operating temperature range (min, max)	-40°C...+125°C
Tightening torque for PE connection	1,2 Nm

Material properties

Main material	Zinc die-cast
Other materials	Lever: Polyamide (PA) and Stainless steel core Gasket NBR
Colour	RAL 7040 grey
RoHs conformity	Compliant
China RoHs - EFUP	E
REACH SVHC substances	No

General ordering information

EAN13 code	8015747302807
eCl@ss 8.1	27440202
ETIM 7.0	EC000437

Packaging Information

Packaging length	160,00 mm
Packaging height	130,00 mm
Packaging width	270,00 mm
Packaging weight	3,36 kg
Packaging volume	5,62 dm ³
Packaging description	Carton box
Packaging quantity	10 Pcs
Packaging EAN code	8015747302814
Sub-packaging weight	0,34 kg
Sub-packaging description	Plastic bag
Sub-packaging quantity	1 Pcs
Sub-packaging EAN barcode	8015747302821

Part number

MXA 02 IAP25



Catalogue drawings

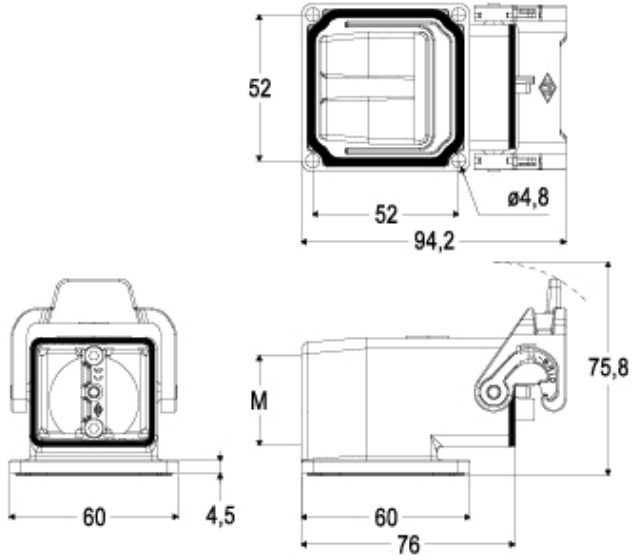

Catalogue drawings

