

Part number

MMAV 06 L40



Hood, 830V series, with 2 pegs, M40 top cable entry, size "77.27", high construction

Product description

Product type	Hood
Series	830V
Closing type	With 2 pegs
Size	Size 77.27
Cable entry	Top cable entry M40
Specification	High construction

Technical data

IP degree of protection IP65 / IP66 / IP69

Further technical details

Weight	230,00 g
Operating temperature range (min, max)	-40°C...+125°C

Material properties

Colour	RAL 7040 grey
RoHs conformity	Compliant
China RoHs - EFUP	E
REACH SVHC substances	No

Approvals / Standards

Certifications	DNV, BV
UL	ECBT2
cUL	ECBT8

General ordering information

EAN13 code 8015747058025

Packaging Information

Sub-packaging weight	1,15 kg
Sub-packaging description	Plastic packaging
Sub-packaging quantity	5 Pcs
Sub-packaging EAN barcode	8015747107693

Part number

MMAV 06 L40



Catalogue drawings

**CMO L (CMAO L) - MMO L [MMAO L]
CMV L [CMAV L] - MMV L (MMAV L)**

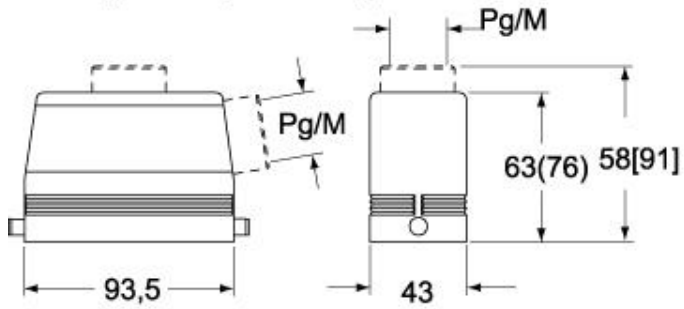

**CMV LG (CMAV LG) - MMV LG (MMAV LG)
[MMFV LG]**

