

Part number

MMAV 03 X40



Hood, 830V series, with 2 levers, M40 top cable entry, size "57.27", high construction, without gasket

Product description		Material properties	
Product type	Hood	Colour	RAL 7040 grey
Series	830V	RoHS conformity	Compliant
Closing type	With 2 levers	China RoHS - EFUP	E
Size	Size 57.27	REACH SVHC substances	No
Cable entry	Top cable entry M40	Approvals / Standards	
Specification	High construction, without gasket	Certifications	DNV, BV
Technical data		UL	ECBT2
IP degree of protection	IP65 / IP66 / IP69	cUL	ECBT8
Further technical details		General ordering information	
Weight	275,00 g	EAN13 code	8015747057967
Operating temperature range (min, max)	-40°C...+125°C	Packaging Information	
		Sub-packaging weight	1,38 kg
		Sub-packaging description	Plastic packaging
		Sub-packaging quantity	5 Pcs
		Sub-packaging EAN barcode	8015747106757

Part number

MMAV 03 X40



Catalogue drawings

CMO X (CMAO X) - MMO X (MMAO X)

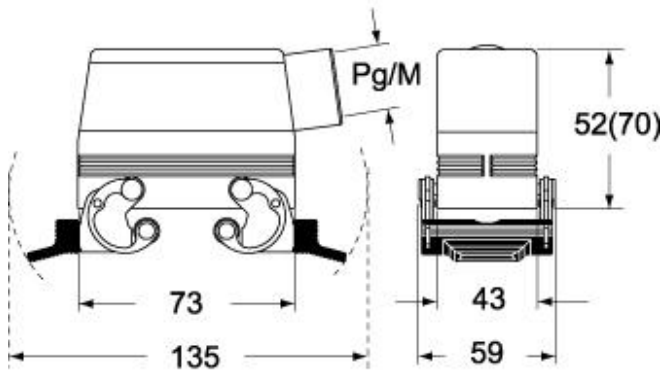

CMV X (CMAV X) - MMV X (MMAV X)

