

Part number

MMAO 03 X40



Hood, 830V series, with 2 levers, M40 side cable entry, size "57.27", high construction, without gasket

Product description

Product type	Hood
Series	830V
Closing type	With 2 levers
Size	Size 57.27
Cable entry	Side cable entry M40
Specification	High construction, without gasket

Technical data

IP degree of protection IP65 / IP66 / IP69

Further technical details

Weight	280,00 g
Operating temperature range (min, max)	-40°C...+125°C

Material properties

Colour	RAL 7040 grey
RoHS conformity	Compliant
China RoHS - EFUP	E
REACH SVHC substances	No

Approvals / Standards

Certifications	DNV, BV
UL	ECBT2
cUL	ECBT8

General ordering information

EAN13 code 8015747057059

Packaging Information

Sub-packaging weight	1,40 kg
Sub-packaging description	Plastic packaging
Sub-packaging quantity	5 Pcs
Sub-packaging EAN barcode	8015747106092

Part number

MMAO 03 X40



Catalogue drawings

CMO X (CMAO X) - MMO X (MMAO X)

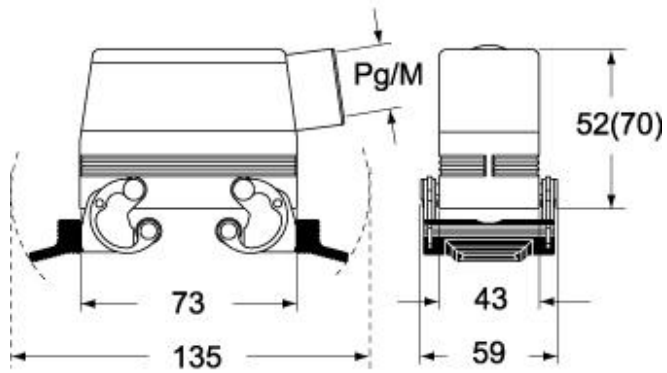

CMV X (CMAV X) - MMV X (MMAV X)

