

Part number

# MHV 24.25



Hood, C-TYPE series, with 4 pegs, M25 top cable entry, size "104.27"

#### Product description

<b>Product type</b>	Hood
<b>Series</b>	C-TYPE
<b>Closing type</b>	With 4 pegs
<b>Size</b>	Size 104.27
<b>Cable entry</b>	Top cable entry M25

#### Technical data

**IP degree of protection** IP65 / IP66 / IP69

#### Further technical details

<b>Weight</b>	179,00 g
<b>Operating temperature range (min, max)</b>	-40°C...+125°C

#### Material properties

<b>Colour</b>	RAL 7040 grey
<b>RoHs conformity</b>	Compliant
<b>China RoHs - EFUP</b>	E
<b>REACH SVHC substances</b>	No

#### Approvals / Standards

<b>Certifications</b>	DNV, BV
<b>UL</b>	ECBT2
<b>cUL</b>	ECBT8

#### General ordering information

<b>EAN13 code</b>	8015747056137
<b>eCl@ss 8.1</b>	27440202
<b>ETIM 7.0</b>	EC000437

#### Packaging Information

<b>Packaging length</b>	305,00 mm
<b>Packaging height</b>	180,00 mm
<b>Packaging width</b>	275,00 mm
<b>Packaging weight</b>	4,02 kg
<b>Packaging volume</b>	15,10 dm <sup>3</sup>
<b>Packaging description</b>	Carton box
<b>Packaging quantity</b>	20 Pcs
<b>Packaging EAN code</b>	8015747056144
<b>Sub-packaging weight</b>	1,01 kg
<b>Sub-packaging description</b>	Plastic packaging
<b>Sub-packaging quantity</b>	5 Pcs
<b>Sub-packaging EAN barcode</b>	8015747056151

Part number

# MHV 24.25



Catalogue drawings

**CHO [CAO] CHV (CAV) - MHO [MAO]  
MHV (MAV)**

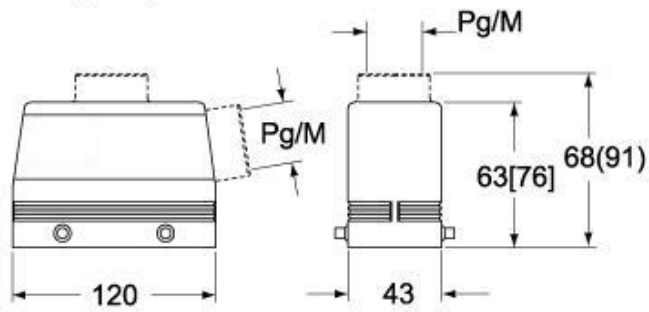

**CHV G (CAV G) - MHV G (MAV G) - [MFV G]**

