

Part number

MHP 50.232



Surface mounting housing, C-TYPE series, with 2 levers, M32 x 2 cable entry, size "66.40"



Product description		Material properties	
Product type	Surface mounting housing	Other materials	Lever: Stainless steel, polyamide (PA) Gasket: NBR
Series	C-TYPE	Colour	RAL 7040 grey
Closing type	With 2 levers	RoHS conformity	Compliant
Size	Size "66.40"	China RoHS - EFUP	E
Cable entry	With cable entry M32 x 2	REACH SVHC substances	No
Technical data		Approvals / Standards	
IP degree of protection	IP65 / IP66 / IP69	Certifications	DNV, BV
Further technical details		UL	ECBT2
Weight	475,00 g	cUL	ECBT8
Operating temperature range (min, max)	-40°C...+125°C	General ordering information	
		EAN13 code	8015747055239
		eCl@ss 8.1	27440202
		ETIM 7.0	EC000437
		Packaging Information	
		Packaging length	350,00 mm
		Packaging height	105,00 mm
		Packaging width	145,00 mm
		Packaging weight	2,54 kg
		Packaging volume	5,33 dm ³
		Packaging description	Carton box
		Packaging quantity	5 Pcs
		Packaging EAN code	8015747055246

Part number

MHP 50.232



Catalogue drawings

CHP - MHP



CHP CS - MHP CS

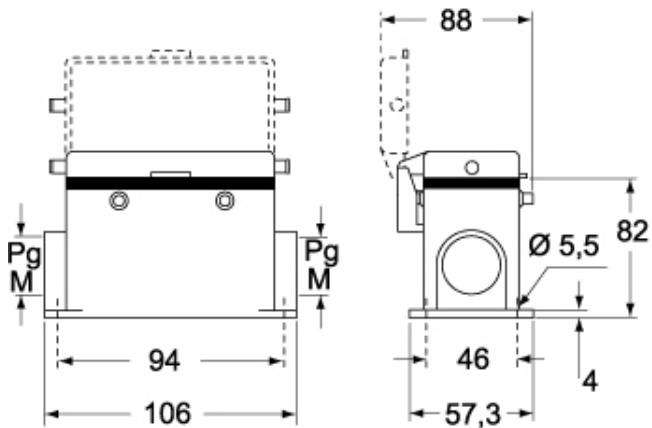

Catalogue drawings

