

Part number

MGP 06.32



Surface mounting housing, IP68 series, for 2 screws, M32 cable entry, size "44.27"

Product description

Product type	Surface mounting housing
Series	IP68
Closing type	With 2 screws
Size	Size 44.27
Cable entry	With cable entry M32

Technical data

IP degree of protection IP66 / IP68 / IP69

Further technical details

Weight	774,00 g
Operating temperature range (min, max)	-40°C...+125°C

Material properties

Main material	Aluminium die-cast
Other materials	Gasket: NBR
Colour	RAL 9005 black
RoHs conformity	Compliant
China RoHs - EFUP	E
REACH SVHC substances	No

Approvals / Standards

Certifications	DNV, BV
UL	ECBT2
cUL	ECBT8

General ordering information

EAN13 code	8015747145879
eCl@ss 8.1	27440202
ETIM 7.0	EC000437

Packaging Information

Packaging length	180,00 mm
Packaging height	120,00 mm
Packaging width	155,00 mm
Packaging weight	1,55 kg
Packaging volume	3,35 dm ³
Packaging description	Carton box
Packaging quantity	2 Pcs
Packaging EAN code	8015747146005
Sub-packaging weight	0,78 kg
Sub-packaging description	Plastic packaging
Sub-packaging quantity	1 Pcs
Sub-packaging EAN barcode	8015747146012

Part number

MGP 06.32



Catalogue drawings

CGP - MGP

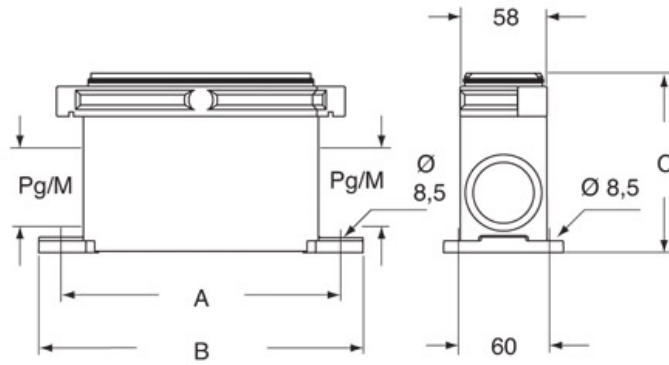

	A	B	C
CGP 06 - MGP 06	127	156	110
CGP 10 - MGP 10	140	169	110
CGP 16 - MGP 16	160	189	121
CGP 24 - MGP 24	187	216	121