

Part number

# MFV 32.50



Hood, C-TYPE series, with 4 pegs, M50 top cable entry without adapter, size "77.62"

#### Product description

|                     |                        |
|---------------------|------------------------|
| <b>Product type</b> | Hood                   |
| <b>Series</b>       | C-TYPE                 |
| <b>Closing type</b> | With 4 pegs            |
| <b>Size</b>         | Size 77.62             |
| <b>Cable entry</b>  | Top cable entry<br>M50 |

#### Technical data

|                                |                    |
|--------------------------------|--------------------|
| <b>IP degree of protection</b> | IP65 / IP66 / IP69 |
|--------------------------------|--------------------|

#### Further technical details

|   |                |
|---|----------------|
| <b>Weight</b>                                 | 360,50 g       |
| <b>Operating temperature range (min, max)</b> | -40°C...+125°C |

#### Material properties

|                              |               |
|------------------------------|---------------|
| <b>Colour</b>                | RAL 7040 grey |
| <b>RoHs conformity</b>       | Compliant     |
| <b>China RoHs - EFUP</b>     | E             |
| <b>REACH SVHC substances</b> | No            |

#### Approvals / Standards

|                       |         |
|-----------------------|---------|
| <b>Certifications</b> | DNV, BV |
| <b>UL</b>             | ECBT2   |
| <b>cUL</b>            | ECBT8   |

#### General ordering information

|                   |               |
|-------------------|---------------|
| <b>EAN13 code</b> | 8015747152297 |
| <b>eCl@ss 8.1</b> | 27440202      |
| <b>ETIM 7.0</b>   | EC000437      |

#### Packaging Information

|                                  |                       |
|----------------------------------|-----------------------|
| <b>Packaging length</b>          | 370,00 mm             |
| <b>Packaging height</b>          | 140,00 mm             |
| <b>Packaging width</b>           | 210,00 mm             |
| <b>Packaging weight</b>          | 3,10 kg               |
| <b>Packaging volume</b>          | 10,88 dm <sup>3</sup> |
| <b>Packaging description</b>     | Carton box            |
| <b>Packaging quantity</b>        | 8 Pcs                 |
| <b>Packaging EAN code</b>        | 8015747099103         |
| <b>Sub-packaging weight</b>      | 0,39 kg               |
| <b>Sub-packaging description</b> | Plastic packaging     |
| <b>Sub-packaging quantity</b>    | 1 Pcs                 |
| <b>Sub-packaging EAN barcode</b> | 8015747101806         |

Part number

# MFV 32.50



Catalogue drawings

**CHO - CHV MHO/MFO/MFV - MHV  
MMV (MMAV)**

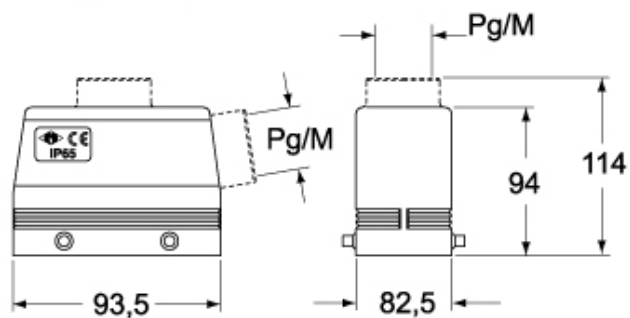

**CHV G - MHV G - MFV G**

