

Part number

MAV 10.32



Hood, C-TYPE series, with 4 pegs, M32 top cable entry, size "57.27", high construction

Product description		Material properties	
Product type	Hood	Colour	RAL 7040 grey
Series	C-TYPE	RoHs conformity	Compliant
Closing type	With 4 pegs	China RoHs - EFUP	E
Size	Size 57.27	REACH SVHC substances	No
Cable entry	Top cable entry M32	Approvals / Standards	
Specification	High construction	Certifications	DNV, BV
Technical data		UL	ECBT2
IP degree of protection	IP65 / IP66 / IP69	cUL	ECBT8
Further technical details		General ordering information	
Weight	176,00 g	EAN13 code	8015747052337
Operating temperature range (min, max)	-40°C...+125°C	eCl@ss 8.1	27440202
		ETIM 7.0	EC000437
		Packaging Information	
		Packaging length	270,00 mm
		Packaging height	130,00 mm
		Packaging width	180,00 mm
		Packaging weight	1,85 kg
		Packaging volume	6,32 dm ³
		Packaging description	Carton box
		Packaging quantity	10 Pcs
		Packaging EAN code	8015747264570
		Sub-packaging weight	0,93 kg
		Sub-packaging description	Plastic packaging
		Sub-packaging quantity	5 Pcs
		Sub-packaging EAN barcode	8015747052344

Part number

MAV 10.32



Catalogue drawings

**CHO [CAO] CHV (CAV) - MHO [MAO]
MHV (MAV)**

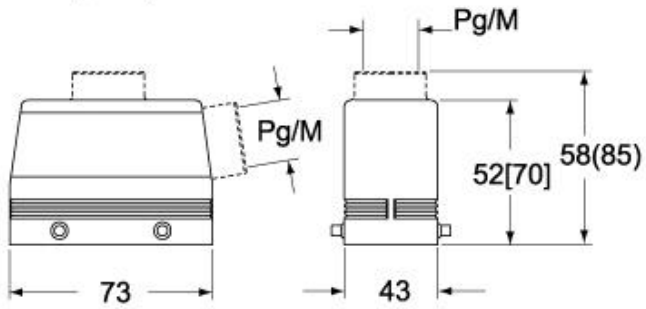

CAF - MAF/MFF

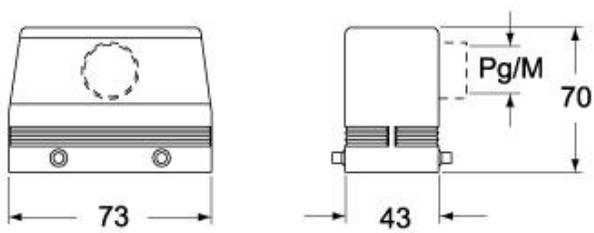

CHV G (CAV G) - MHV G (MAV G) - [MFV G]

