

Part number

MAP 10 CS32



Surface mounting housing, C-TYPE series, with 4 pegs, M32 cable entry, size "57.27", high construction, with metal cover

Product description

Product type	Surface mounting housing
Series	C-TYPE
Closing type	With 4 pegs
Size	Size 57.27
Cable entry	With cable entry M32
Specification	High construction, with metal cover

Technical data

IP degree of protection IP65

Further technical details

Weight	340,00 g
Operating temperature range (min, max)	-40°C...+125°C

Material properties

Other materials	Gasket: NBR
Colour	RAL 7040 grey
RoHs conformity	Compliant
China RoHs - EFUP	E
REACH SVHC substances	No

Approvals / Standards

Certifications	DNV, BV
UL	ECBT2
cUL	ECBT8

General ordering information

EAN13 code	8015747051101
eCl@ss 8.1	27440202
ETIM 7.0	EC000437

Packaging Information

Packaging length	475,00 mm
Packaging height	200,00 mm
Packaging width	150,00 mm
Packaging weight	3,70 kg
Packaging volume	14,25 dm ³
Packaging description	Carton box
Packaging quantity	10 Pcs
Packaging EAN code	8015747244329
Sub-packaging weight	1,85 kg
Sub-packaging description	Plastic packaging
Sub-packaging quantity	5 Pcs
Sub-packaging EAN barcode	8015747244336

Part number

MAP 10 CS32



Catalogue drawings

CHP CAP - MHP MAP

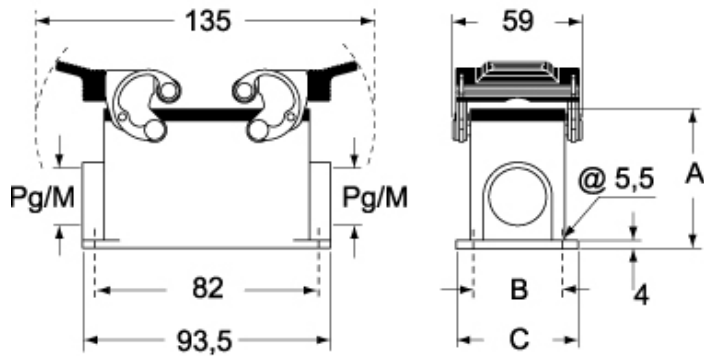

CHP CS/CP CAP CS/CP - MHP CS/CP MAP CS/CP

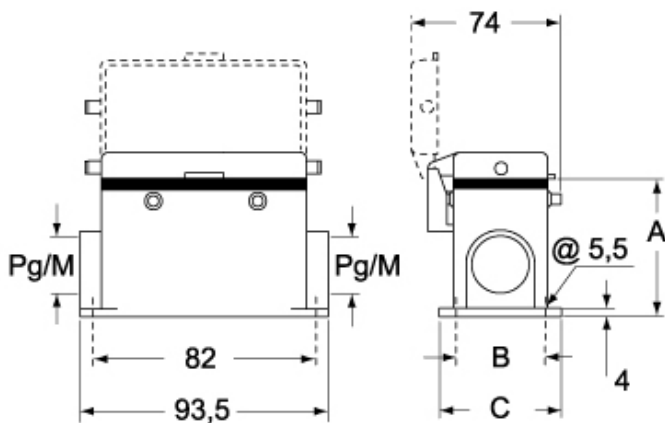

	A	B	C
CHP L / MHP L	57	40	52
CAP L / MAP L	73	45	57
CHP CS / MHP CS	57	40	52
CAP CS / MAP CS	73	45	57
CHP CP / MHP CP	57	40	52
CAP CP / MAP CP	73	45	57