

Part number

FM 3236 CL



Box system for socket-outlet combinations, FM series, with smooth cover, alveolated on the rear

Product description	
Product type	Box system for socket-outlet combinations
Series	FM
Size	320 x 360 x 135 mm
Specification	With smooth cover, alveolated on the rear
Technical data	
IP degree of protection	IP55
Further technical details	
Weight	2.018,00 g
Operating temperature range (min, max)	-40°C ... +125°C

Material properties	
Colour	RAL 7035 grey
General ordering information	
EAN13 code	8015747047524
Packaging Information	
Packaging length	340,00 mm
Packaging height	150,00 mm
Packaging width	375,00 mm
Packaging weight	2,10 kg
Packaging volume	19,13 dm ³
Packaging description	Carton box
Packaging quantity	1 Pcs
Packaging EAN code	8015747047531

Part number

FM 3236 CL



Catalogue drawings

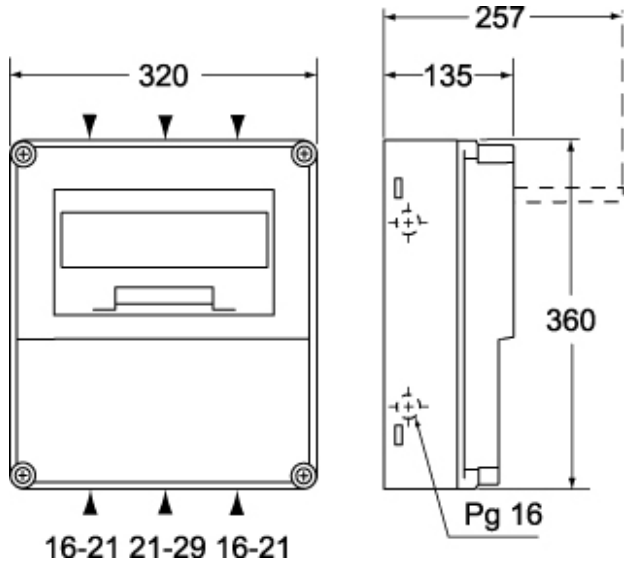

Catalogue drawings

