

Part number

FC 1414 DB



Box, FC series, with fixed cover, for FC 1453 TB plate

Product description

Product type	Box
Series	FC
Specification	With fixed cover For FC 1453 TB plate

Technical data

IP degree of protection IP44

Further technical details

Weight	370,00 g
Operating temperature range (min, max)	-40°C ... +125°C

Material properties

Colour RAL 7035 grey

General ordering information

EAN13 code 8015747045438

Packaging Information

Packaging length	335,00 mm
Packaging height	320,00 mm
Packaging width	400,00 mm
Packaging weight	8,40 kg
Packaging volume	42,88 dm ³
Packaging description	Carton box
Packaging quantity	20 Pcs
Packaging EAN code	8015747045445
Sub-packaging weight	0,42 kg
Sub-packaging description	Plastic packaging
Sub-packaging quantity	1 Pcs
Sub-packaging EAN barcode	8015747113199

Part number

FC 1414 DB



Catalogue drawings

FC 1114 DB/DB5

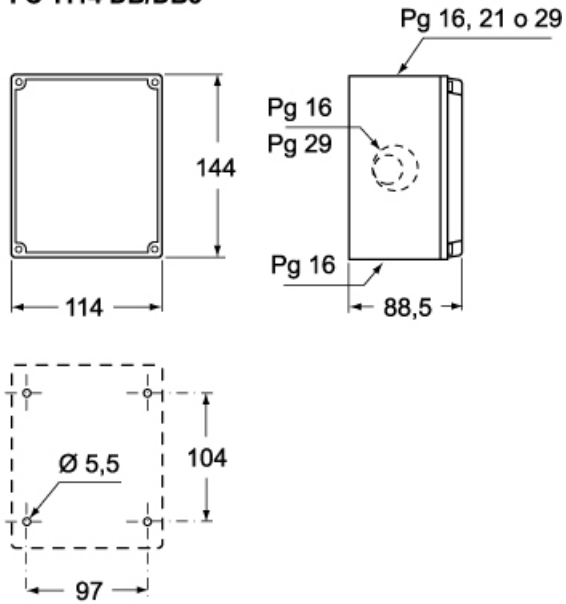

FC 1414 DB/DB5

