

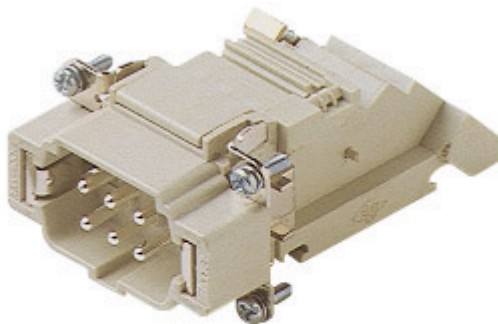

Part number

CTSEM 06 R



Male insert, CTSE series, spring terminal connection, 6 poles + PE, 16 A 500 V 6 kV 3, size "44.27", with incorporated terminal block, right side mounting

Product description

Product type	Insert
Series	CTSE
Connection type	Spring terminal connection
Gender	Male
N. of poles	6 poles + 
Size	Size 44.27
Specification	Right side mounting With incorporated terminal block

Technical data

Current	16 A
Voltage	500 V
Rated impulse withstand voltage	6 kV
Pollution degree	3
Rated voltage according to UL/CSA	600 V
Wire cross-section	0,14 mm ² - 2,50 mm ²
AWG size	26 - 14
Contact type	Turned silver plated
IP degree of protection	IP20 without enclosure, IP66/IP69 with enclosure

Further technical details

Characteristics according to EN 61984	16A 500V 6kV 3; 16A 400/690V 6kV 2
Mating cycles	≥ 500
Insulation resistance	≥ 10 GΩ
Contact resistance	≤ 4 mΩ
Weight	79,00 g
Operating temperature range (min, max)	-40 °C ... +125 °C
Conductors stripping length	9...11 mm
UL 94 flammability rating	V-0

Material properties

Main material	Polycarbonate (PC)
Other materials	Contacts: copper alloy
Colour	RAL 7032 grey
RoHs conformity	Compliant with exemption 6(c): copper alloy containing up to 4% lead by weight
China RoHs - EFUP	50
REACH SVHC substances	Yes Lead
SCIP number	1a9c93ff-0445-4a16-81e3-1609ac5274d6

Approvals / Standards

Reference standard	EN 61984:2009-06
Certifications	CSAc, CQC, DNV, BV, EAC
UL	ECBT2

General ordering information

EAN13 code	8015747122443
eCl@ss 8.1	27440205
ETIM 7.0	EC000438

Packaging Information

Packaging weight	0,42 kg
Packaging description	Carton box
Packaging quantity	4 Pcs
Packaging EAN code	8015747123778
Sub-packaging length	75,00 mm
Sub-packaging height	89,00 mm
Sub-packaging width	110,00 mm
Sub-packaging weight	0,11 kg
Sub-packaging volume	0,73 dm ³
Sub-packaging description	Plastic packaging
Sub-packaging quantity	1 Pcs
Sub-packaging EAN barcode	8015747123785

Part number

CTSEM 06 R



Catalogue drawings

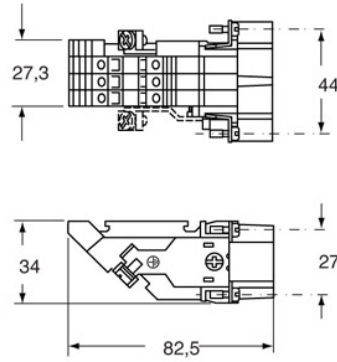
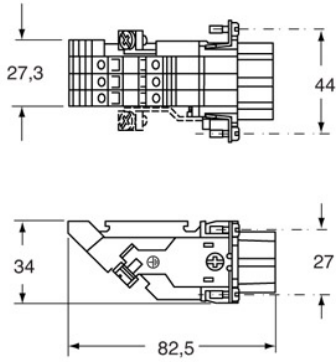

Catalogue drawings

