

Part number

# COB 10 BC



Connector carrier baseplate for mounting on DIN EN60715 rail or with screws, COB panel supports series, for inserts with 57 x 27 mm screw fixing centre distance

## Product description

<b>Product type</b>	Connector carrier baseplate for mounting on DIN EN60715 rail or with screws
<b>Series</b>	COB panel supports
<b>Specification</b>	For inserts with 57 x 27 mm screw fixing centre distance

## Technical data

<b>IP degree of protection</b>	IP20
--------------------------------	------

## Further technical details

<b>Weight</b>	84,50 g
<b>Operating temperature range (min, max)</b>	-40°C...+125°C

## Material properties

<b>Colour</b>	RAL 7032 grey
<b>RoHs conformity</b>	Compliant with exemption 6(c): copper alloy containing up to 4% lead by weight
<b>China RoHs - EFUP</b>	50
<b>REACH SVHC substances</b>	Yes Lead
<b>SCIP number</b>	B008b8e4-629e-4e70-ab7d-b3b67464925d

## Approvals / Standards

<b>Certifications</b>	DNV, BV
<b>UL</b>	ECBT2
<b>cUL</b>	ECBT8

## General ordering information

<b>EAN13 code</b>	8015747036528
<b>eCl@ss 8.1</b>	27440206
<b>ETIM 7.0</b>	EC002312

## Packaging Information

<b>Packaging length</b>	275,00 mm
<b>Packaging height</b>	110,00 mm
<b>Packaging width</b>	430,00 mm
<b>Packaging weight</b>	2,14 kg
<b>Packaging volume</b>	13,01 dm <sup>3</sup>
<b>Packaging description</b>	Carton box
<b>Packaging quantity</b>	20 Pcs
<b>Packaging EAN code</b>	8015747036535
<b>Sub-packaging length</b>	95,00 mm
<b>Sub-packaging height</b>	40,00 mm
<b>Sub-packaging width</b>	253,00 mm
<b>Sub-packaging weight</b>	0,54 kg
<b>Sub-packaging volume</b>	0,96 dm <sup>3</sup>
<b>Sub-packaging description</b>	Carton tray
<b>Sub-packaging quantity</b>	5 Pcs
<b>Sub-packaging EAN barcode</b>	8015747036542

Part number

# COB 10 BC



Catalogue drawings

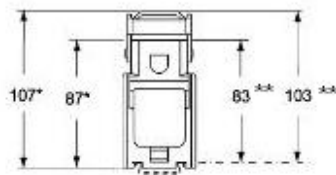
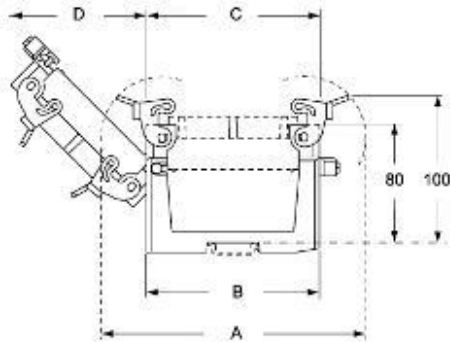

Catalogue drawings

**COB..BC**

