

Part number

CMV 06 G



Hood, 830V series, with 2 levers, Pg21 top cable entry, size "77.27"

Product description		Material properties	
Product type	Hood	Colour	RAL 7040 grey
Series	830V	RoHs conformity	Compliant
Closing type	With 2 levers	China RoHs - EFUP	E
Size	Size 77.27	REACH SVHC substances	No
Cable entry	Top cable entry Pg21	Approvals / Standards	
Technical data		Certifications	DNV, BV
IP degree of protection	IP65 / IP66 / IP69	UL	ECBT2
Further technical details		cUL	ECBT8
Weight	249,00 g	General ordering information	
Operating temperature range (min, max)	-40°C...+125°C	EAN13 code	8015747031844
		Packaging Information	
		Sub-packaging weight	1,25 kg
		Sub-packaging description	Plastic packaging
		Sub-packaging quantity	5 Pcs
		Sub-packaging EAN barcode	8015747031851

Part number

CMV 06 G



Catalogue drawings

**CMO [CMAO] CMV (CMAV) - MMO [MMAO]
MMV (MMAV)**

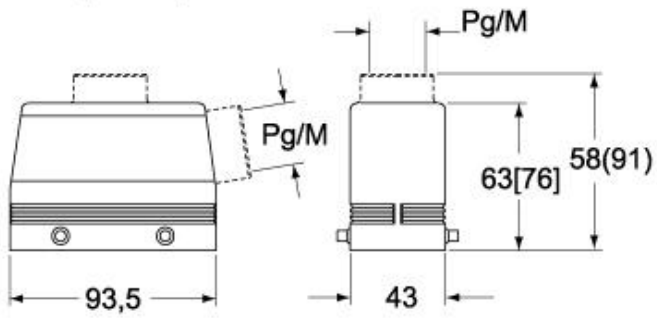

CMV G (CMAV G) - MMV G (MMAV G) - [MMFV G]

