

Part number
CKFD 03



Female insert, CK series, screw terminal connection, 3 poles + PE, 10 A 230/400 V 4 kV 3, size "21.21"

Product description		Material properties	
Product type	Insert	Main material	Polycarbonate (PC)
Series	CK	Other materials	Contacts: copper alloy
Connection type	Screw terminal connection	Colour	RAL 7032 grey
Gender	Female	RoHs conformity	Compliant with exemption 6(c): copper alloy containing up to 4% lead by weight
N. of poles	3 poles +	China RoHs - EFUP	50
Size	Size "21.21"	REACH SVHC substances	Yes Lead
Technical data		SCIP number	1a9c93ff-0445-4a16-81e3-1609ac5274d6
Current	10 A	Approvals / Standards	
Voltage	230 - 400 V	Reference standard	EN 61984:2009-06
Rated impulse withstand voltage	4 kV	Certifications	CSA, CQC, DNV, BV, EAC
Pollution degree	3	UL	ECBT2
Rated voltage according to UL/CSA	600 V	General ordering information	
Wire cross-section	0,75 mm ² - 2,50 mm ²	EAN13 code	8015747028134
AWG size	18 - 14	eCl@ss 8.1	27440205
Contact type	Turned gold plated	ETIM 7.0	EC000438
IP degree of protection	IP20 without enclosure, IP44/IP66/IP67/IP68/IP69 with enclosure	Packaging Information	
Further technical details		Packaging length	210,00 mm
Characteristics according to EN 61984	10A 230/400V 4kV 3; 10A 400/690V 4kV 2	Packaging height	200,00 mm
Mating cycles	≥ 500	Packaging width	130,00 mm
Insulation resistance	≥ 10 GΩ	Packaging weight	3,00 kg
Contact resistance	≤ 2 mΩ	Packaging volume	5,46 dm ³
Weight	13,00 g	Packaging description	Carton box
Operating temperature range (min, max)	-40°C ... +100°C	Packaging quantity	200 Pcs
Conductors stripping length	6 mm	Packaging EAN code	8015747190497
UL 94 flammability rating	V-1	Sub-packaging length	197,00 mm
Torque for main contact	M3: 0,5 Nm; 4,4 lb.in (0,5 x 3 mm)	Sub-packaging height	35,00 mm
Tightening torque for PE connection	M3: 0,5 Nm; 4,4 lb.in (0,5 x 3 mm)	Sub-packaging width	113,00 mm
Tightening torque for fixing screws	M3: 0,5 Nm; 4,4 lb.in (Ph1 or 0,8 x 5,5 mm)	Sub-packaging weight	0,60 kg
		Sub-packaging volume	0,78 dm ³
		Sub-packaging description	Carton tray
		Sub-packaging quantity	40 Pcs
		Sub-packaging EAN barcode	8015747111799

Part number

CKFD 03



Catalogue drawings

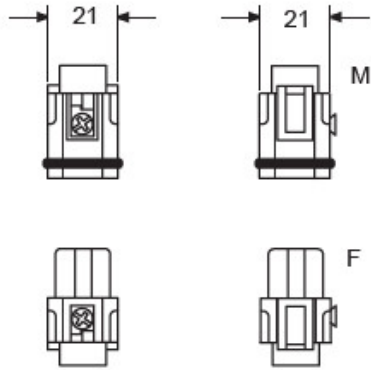

contacts side (front view)

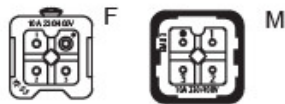

Derating curves

CKD 03 poles connector inserts
Maximum current load derating diagram

