

Part number

# CHP 50 CS2



Surface mounting housing, C-TYPE series, with 4 pegs, Pg21 x 2 cable entry, size "66.40", with metal cover

<b>Product description</b>		<b>Material properties</b>	
<b>Product type</b>	Surface mounting housing	<b>Other materials</b>	Gasket: NBR
<b>Series</b>	C-TYPE	<b>Colour</b>	RAL 7040 grey
<b>Closing type</b>	With 4 pegs	<b>RoHs conformity</b>	Compliant
<b>Size</b>	Size "66.40"	<b>China RoHs - EFUP</b>	E
<b>Cable entry</b>	With cable entry Pg21 x 2	<b>REACH SVHC substances</b>	No
<b>Specification</b>	With metal cover	<b>Approvals / Standards</b>	
<b>Technical data</b>		<b>Certifications</b>	DNV, BV
<b>IP degree of protection</b>	IP65	<b>UL</b>	ECBT2
<b>Further technical details</b>		<b>cUL</b>	ECBT8
<b>Weight</b>	467,00 g	<b>General ordering information</b>	
<b>Operating temperature range (min, max)</b>	-40°C...+125°C	<b>EAN13 code</b>	8015747023177
		<b>Packaging Information</b>	
		<b>Sub-packaging length</b>	175,00 mm
		<b>Sub-packaging height</b>	100,00 mm
		<b>Sub-packaging width</b>	235,00 mm
		<b>Sub-packaging weight</b>	2,34 kg
		<b>Sub-packaging volume</b>	4,11 dm <sup>3</sup>
		<b>Sub-packaging description</b>	Carton box
		<b>Sub-packaging quantity</b>	5 Pcs
		<b>Sub-packaging EAN barcode</b>	8015747023184

Part number

# CHP 50 CS2



Catalogue drawings

## CHP - MHP

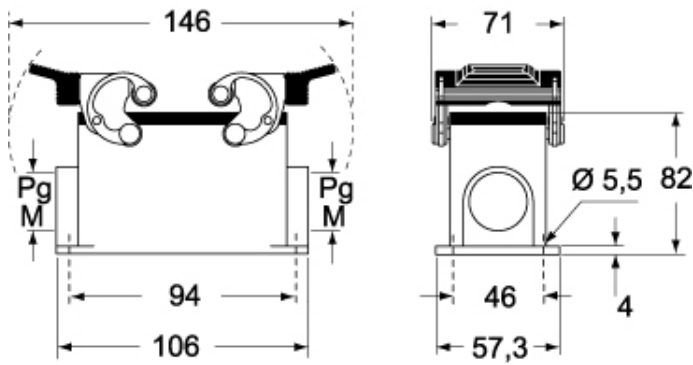

## CHP CS - MHP CS

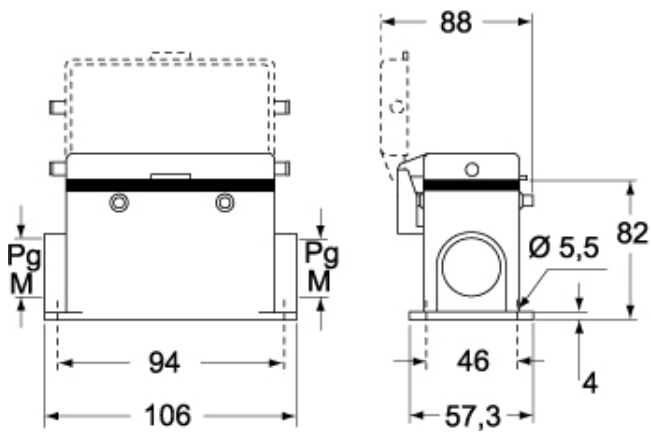

Catalogue drawings

