

Part number

# CAP 06 L2



Surface mounting housing, C-TYPE series, with 1 lever, Pg21 x 2 cable entry, size "44.27", high construction

Product description		Material properties	
<b>Product type</b>	Surface mounting housing	<b>Other materials</b>	Lever: Stainless steel, polyamide (PA) Gasket: NBR
<b>Series</b>	C-TYPE	<b>Colour</b>	RAL 7040 grey
<b>Closing type</b>	With 1 lever	<b>RoHs conformity</b>	Compliant
<b>Size</b>	Size 44.27	<b>China RoHs - EFUP</b>	E
<b>Cable entry</b>	With cable entry Pg21 x 2	<b>REACH SVHC substances</b>	No
<b>Specification</b>	High construction	<b>Approvals / Standards</b>	
<b>Technical data</b>		<b>Certifications</b>	DNV, BV
<b>IP degree of protection</b>	IP65 / IP66 / IP69	<b>UL</b>	ECBT2
<b>Further technical details</b>		<b>cUL</b>	ECBT8
<b>Weight</b>	310,00 g	<b>General ordering information</b>	
<b>Operating temperature range (min, max)</b>	-40°C...+125°C	<b>EAN13 code</b>	8015747007375
		<b>Packaging Information</b>	
		<b>Packaging length</b>	475,00 mm
		<b>Packaging height</b>	200,00 mm
		<b>Packaging width</b>	150,00 mm
		<b>Packaging weight</b>	3,40 kg
		<b>Packaging volume</b>	14,25 dm <sup>3</sup>
		<b>Packaging description</b>	Carton box
		<b>Packaging quantity</b>	10 Pcs
		<b>Packaging EAN code</b>	8015747236072
		<b>Sub-packaging weight</b>	1,70 kg
		<b>Sub-packaging description</b>	Plastic packaging
		<b>Sub-packaging quantity</b>	5 Pcs
		<b>Sub-packaging EAN barcode</b>	8015747007382

Part number

# CAP 06 L2



Catalogue drawings

## CHP L CAP L - MHP L MAP L

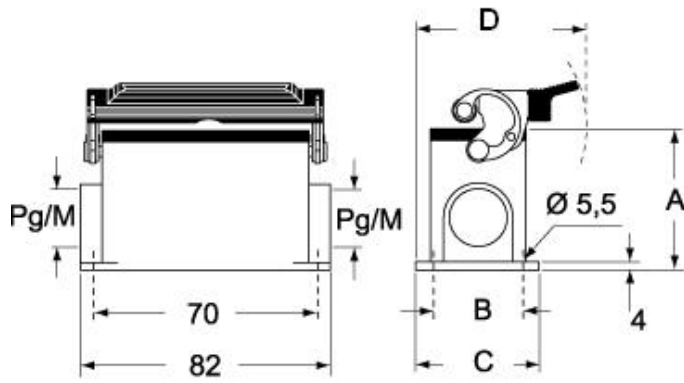

## CHP LS CAP LS - MHP LS MAP LS

