

Part number

CAO 06 L21



Hood, C-TYPE series, with 2 pegs, Pg21 side cable entry, size "44.27", high construction

Product description

Product type	Hood
Series	C-TYPE
Closing type	With 2 pegs
Size	Size 44.27
Cable entry	Side cable entry with adapter Pg21
Specification	High construction

Technical data

IP degree of protection IP65 / IP66 / IP69

Further technical details

Weight	184,50 g
Operating temperature range (min, max)	-40°C...+125°C

Material properties

Colour	RAL 7040 grey
RoHs conformity	Compliant with exemption 6(c): copper alloy containing up to 4% lead by weight
China RoHs - EFUP	50
REACH SVHC substances	Yes Lead
SCIP number	15deaf78-e939-4401-a0b0-e2228ca32a03

Approvals / Standards

Certifications	DNV, BV
UL	ECBT2
cUL	ECBT8

General ordering information

EAN13 code 8015747006064

Packaging Information

Packaging length	260,00 mm
Packaging height	100,00 mm
Packaging width	150,00 mm
Packaging weight	1,95 kg
Packaging volume	3,90 dm ³
Packaging description	Carton box
Packaging quantity	10 Pcs
Packaging EAN code	8015747215411
Sub-packaging weight	0,98 kg
Sub-packaging description	Plastic packaging
Sub-packaging quantity	5 Pcs
Sub-packaging EAN barcode	8015747006071

Part number

CAO 06 L21



Catalogue drawings

CHO LX CHV LX - MHO LX MHV LX



CHV LG (CAV LG), MHV LG (MAV LG) [MFV LG]

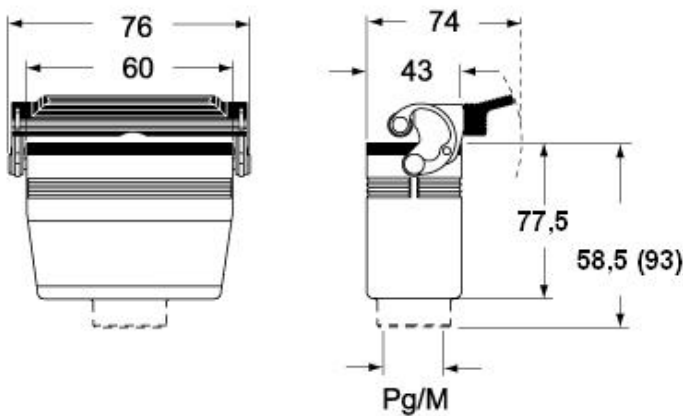

CHO L (CAO L) - MHO (MAO/MFO/MFV L) MHV L [MAV L]

