

Part number

C30MA 95 P



Male crimp contact, C30 series, 300 A, turned silver plated, wire cross section 95 mm², AWG 3/0, finger-proof version

Product description		Material properties	
Product type	Crimp contact	Main material	Copper alloy
Series	C30	Other materials	Cap: polycarbonate (PC)
Gender	Male		Compliant with exemption 6(c): copper alloy containing up to 4% lead by weight
Specification	Finger-proof version	RoHs conformity	
Technical data		China RoHs - EFUP	50
Current	300 A	REACH SVHC substances	Yes Lead
Wire cross-section	95,00 mm ²	General ordering information	
Contact type	Turned silver plated	EAN13 code	8015747290968
Further technical details		Packaging Information	
Contact resistance	≤ 0,2 mΩ	Packaging length	112,00 mm
Weight	48,00 g	Packaging height	95,00 mm
Conductors stripping length	22,5 mm	Packaging width	117,00 mm
		Packaging volume	1,24 dm ³
		Packaging description	Carton box
		Packaging quantity	40 Pcs
		Packaging EAN code	8015747290975
		Sub-packaging description	Plastic box
		Sub-packaging quantity	5 Pcs
		Sub-packaging EAN barcode	8015747290982

Part number

C30MA 95 P



Catalogue drawings

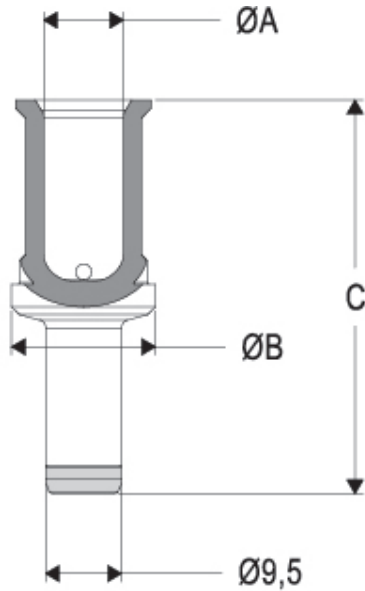

C30MA..P contacts

conductor section (mm ²)	conductor slot $\varnothing A$ (mm)	$\varnothing B$ (mm)	C (mm)	conductor stripping length (mm)
16	5,5	18	42,7	19
25	7	18	42,7	19
35	8,2	18	43,7	20
50	10	18	49,2	22,5
70	11,5	18	49,2	22,5
95	13,5	21	49,2	22,5
120	15,5	21	49,2	22,5