

Part number

# BK 3235



Interlocked switched socket-outlet, BK series, 3 poles + N + PE, 3 h (red), 32 A, 220/380 V, sectionable fuse carrier 10 x 38 mm

#### Product description

<b>Product type</b>	Interlocked switched socket-outlet
<b>Series</b>	BK
<b>N. of poles</b>	3 poles + N + 
<b>Clock position</b>	3
<b>Specification</b>	Sectionable fuse carrier 10 x 38 mm

#### Technical data

<b>Current</b>	32 A
<b>Voltage</b>	220/380V (50Hz) 250/440V (60Hz)
<b>IP degree of protection</b>	IP67

#### Further technical details

<b>Operating temperature range (min, max)</b>	-25°C ... +40°C
<b>IK rating (impact degree of protection)</b>	IK10

#### Material properties

<b>Colour</b>	RAL 7035 grey, RAL 3000 red
---------------	-----------------------------

#### Approvals / Standards

<b>Reference standard</b>	EN 60309-1, -2 e -4
---------------------------	---------------------

#### General ordering information

<b>EAN13 code</b>	8015747147194
-------------------	---------------

Part number

# BK 3235



Catalogue drawings

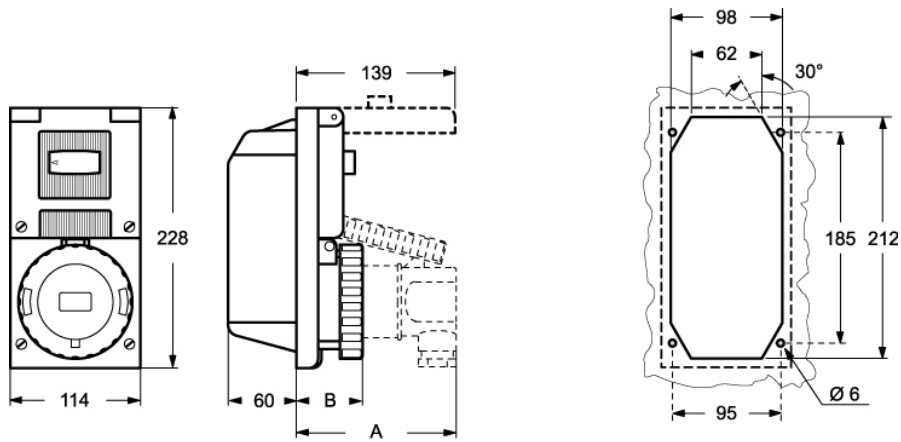

BK		A	B
16A	2P + ⊕	105	50
	3P + ⊕	105	50
	3P + N + ⊕	110	50
32A	2P + ⊕	140	58
	3P + ⊕	140	58
	3P + N + ⊕	140	58