

Part number

# TM 1623 SIR



Interlocked switched socket-outlet, TM series, 2 poles + PE, 2 h (green), 16 A, > 50 V, with compartment for modular units, 4,5 DIN-rail modules EN 60715, without base box

#### Product description

<b>Product type</b>	Interlocked switched socket-outlet
<b>Series</b>	TM..SIR/KSIR
<b>N. of poles</b>	2 poles + 
<b>Clock position</b>	2
<b>Specification</b>	With compartment for modular units, 4,5 DIN-rail modules EN 60715 Without base box

#### Technical data

<b>Current</b>	16 A
<b>Voltage</b>	> 50 V
<b>IP degree of protection</b>	IP66 / IP67

#### Further technical details

<b>Operating temperature range (min, max)</b>	-25°C ... +40°C
<b>UL 94 flammability rating</b>	V-2
<b>IK rating (impact degree of protection)</b>	IK10

#### Material properties

<b>Colour</b>	RAL 7012 grey, RAL 6017 green
---------------	-------------------------------

#### Approvals / Standards

<b>Reference standard</b>	EN 60309-1, -2 e -4
---------------------------	---------------------

#### General ordering information

<b>EAN13 code</b>	8015747160933
-------------------	---------------

Part number

# TM 1623 SIR



Catalogue drawings

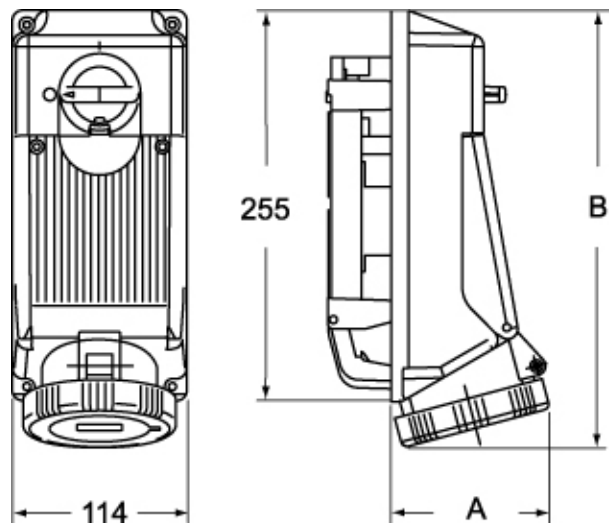

	<b>A</b>	<b>B</b>
<b>2P+⊕</b>	83	276
<b>3P+⊕</b>	85	276
<b>3P+N+⊕</b>	90	277