

Part number

# SQE 1624.5



Interlocked switched socket-outlet, SQE series, 3 poles + PE, 2 h (green), 16 A, > 50 V, without fuse-carrier

Product description	
<b>Product type</b>	Interlocked switched socket-outlet
<b>Series</b>	SQE
<b>N. of poles</b>	3 poles + 
<b>Clock position</b>	2
<b>Specification</b>	Without fuse-carrier
Technical data	
<b>Current</b>	16 A
<b>Voltage</b>	> 50 V
<b>IP degree of protection</b>	IP55
Further technical details	
<b>Operating temperature range (min, max)</b>	-25°C ... +40°C
<b>IK rating (impact degree of protection)</b>	IK08

Material properties	
<b>Colour</b>	RAL 7035 grey, RAL 6017 green
Approvals / Standards	
<b>Reference standard</b>	EN 60309-1, -2 e -4
General ordering information	
<b>EAN13 code</b>	8015747159807

Part number

# SQE 1624.5



Catalogue drawings

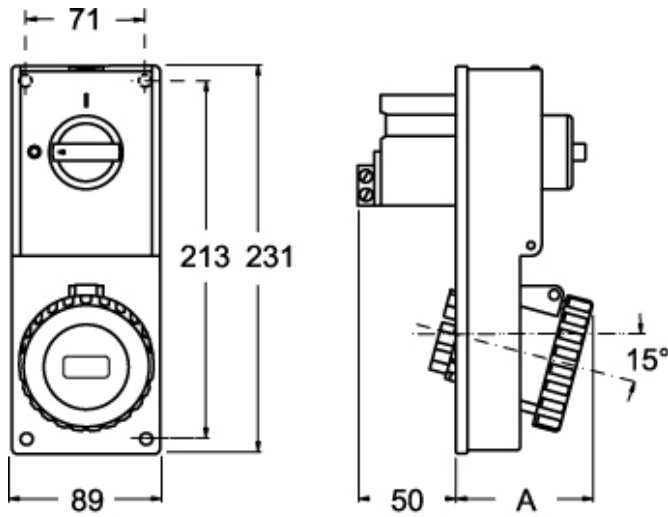

Catalogue drawings

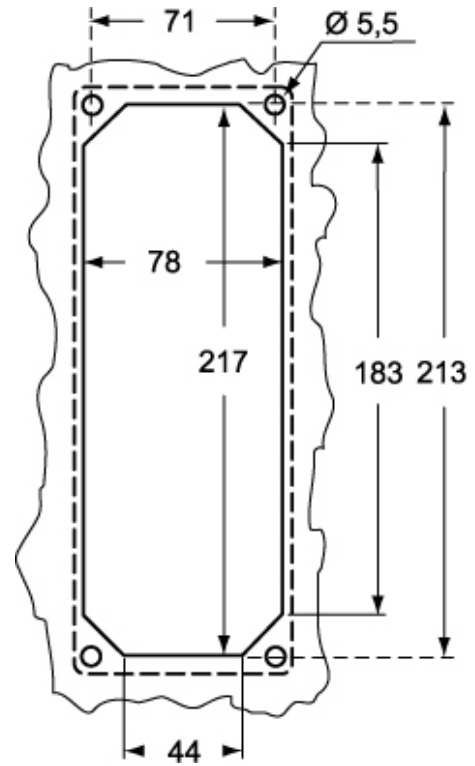

SQE.5		A
16A	2P+⊕	67
	3P+⊕	67
	3P+N+⊕	70