

Part number

SIF2D 0.2R

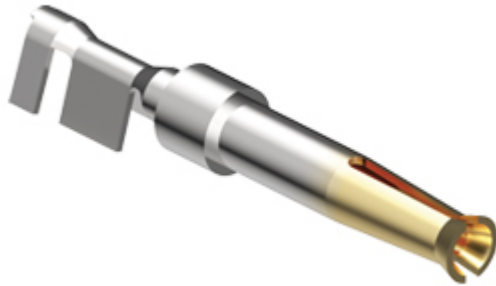

Female crimp contact, SI series, 5 A, stamped gold plated, wire cross section 0,08 - 0,21 mm², AWG 28 - 24, reel packaging, for 250 mating cycles

Product description

Product type	Crimp contact
Series	SI
Gender	Female
Specification	Reel packaging For 250 mating cycles

Technical data

Current	5 A
Wire cross-section	0,08 mm ² - 0,21 mm ²
AWG size	28 - 24
Contact type	Stamped gold plated

Further technical details

Contact resistance	≤ 10 mΩ
Weight	0,19 g
Conductors stripping length	3 mm

Material properties

RoHS conformity	Compliant
China RoHS - EFUP	E
REACH SVHC substances	No

Approvals / Standards

Certifications	EAC
UL	ECBT2
cUL	ECBT8

General ordering information

EAN13 code	8015747272391
eCl@ss 8.1	27440204
ETIM 7.0	EC000796

Packaging Information

Packaging weight	2,15 kg
Packaging description	Plastic bag
Packaging quantity	10000 Pcs
Packaging EAN code	8015747273992

Part number

SIF2D 0.2R



Catalogue drawings

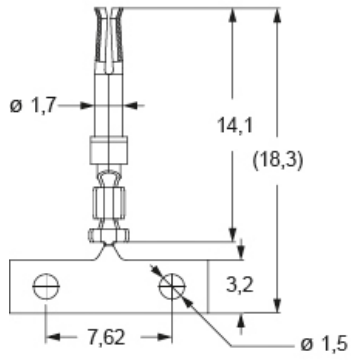

SIF..D R

Reel unrolling left

