

Part number

SIF1D 0.5R

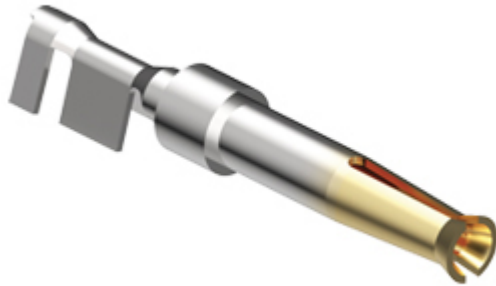

Female crimp contact, SI series, 5 A, stamped gold plated, wire cross section 0,21 - 0,52 mm², AWG 24 - 20, reel packaging, for 500 mating cycles

Product description

Product type	Crimp contact
Series	SI
Gender	Female
Specification	Reel packaging For 500 mating cycles

Technical data

Current	5 A
Wire cross-section	0,21 mm ² - 0,52 mm ²
AWG size	24 - 20
Contact type	Stamped gold plated

Further technical details

Contact resistance	≤ 10 mΩ
Weight	0,20 g
Conductors stripping length	3 mm

Material properties

RoHS conformity	Compliant
China RoHS - EFUP	E
REACH SVHC substances	No

Approvals / Standards

Certifications	EAC
UL	ECBT2
cUL	ECBT8

General ordering information

EAN13 code	8015747277099
eCl@ss 8.1	27440204
ETIM 7.0	EC000796

Packaging Information

Packaging weight	2,17 kg
Packaging description	Plastic bag
Packaging quantity	10000 Pcs
Packaging EAN code	8015747187985

Part number

SIF1D 0.5R



Catalogue drawings

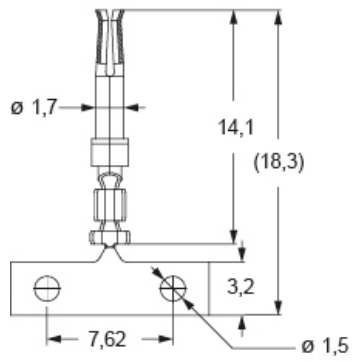

SIF..D R

Reel unrolling left

