

Part number

RDDM 72



Male insert, RDD series, crimp connection, 72 poles + PE, 10 A 250 V 4 kV 2, size "77.27", HNM - High Number of Matings version

Product description

Product type	Insert
Series	RDD
Connection type	Crimp connection
Gender	Male
N. of poles	72 poles + 
Size	Size 77.27
Specification	HNM - High Number of Matings version

Technical data

Current	10 A
Voltage	250 V
Rated impulse withstand voltage	4 kV
Pollution degree	2
Rated voltage according to UL/CSA	600 V
IP degree of protection	IP20 without enclosure, IP65/IP66/IP68/IP69 with enclosure

Further technical details

Mating cycles	≥ 10000
Insulation resistance	≥ 10 GΩ
Contact resistance	≤ 3 mΩ
Weight	58,00 g
Operating temperature range (min, max)	-40 °C ... +125 °C
UL 94 flammability rating	V-0

Material properties

Main material	Polycarbonate (PC)
Colour	RAL 7032 grey
RoHs conformity	Compliant
China RoHs - EFUP	E
REACH SVHC substances	No

Approvals / Standards

Certifications	DNV, BV, EAC
UL	ECBT2
cUL	ECBT8

General ordering information

EAN13 code	8015747255431
eCl@ss 8.1	27440205
ETIM 7.0	EC000438

Packaging Information

Packaging length	230,00 mm
Packaging height	110,00 mm
Packaging width	180,00 mm
Packaging weight	2,04 kg
Packaging volume	4,55 dm ³
Packaging description	Carton box
Packaging quantity	30 Pcs
Packaging EAN code	8015747257138
Sub-packaging length	87,00 mm
Sub-packaging height	36,00 mm
Sub-packaging width	180,00 mm
Sub-packaging weight	0,34 kg
Sub-packaging volume	0,56 dm ³
Sub-packaging description	Carton tray
Sub-packaging quantity	5 Pcs
Sub-packaging EAN barcode	8015747257145

Part number

RDDM 72



Catalogue drawings

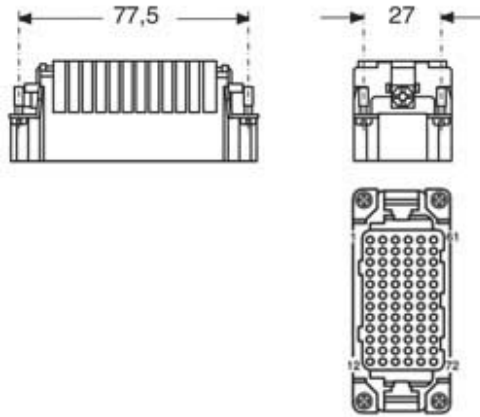

Derating curves

