

Part number

RAC 16 L



Hood, HNM - High Number of Matings series, with 2 pegs without cable entries (to be drilled), size "77.27"

Product description

Product type	Hood
Series	HNM - High Number of Matings
Closing type	With 2 pegs
Size	Size 77.27
Cable entry	Without cable entries (to be drilled)

Technical data

IP degree of protection	IP65 / IP66 / IP69
--------------------------------	--------------------

Further technical details

Operating temperature range (min, max)	-40°C...+125°C
---	----------------

Material properties

Colour	RAL 7040 grey
RoHs conformity	Compliant
China RoHs - EFUP	E
REACH SVHC substances	No

Approvals / Standards

UL	ECBT2
cUL	ECBT8

General ordering information

EAN13 code	8015747255233
eCl@ss 8.1	27440202
ETIM 7.0	EC000437

Packaging Information

Sub-packaging description	Plastic packaging
Sub-packaging quantity	5 Pcs
Sub-packaging EAN barcode	8015747257374

Part number

RAC 16 L



Catalogue drawings

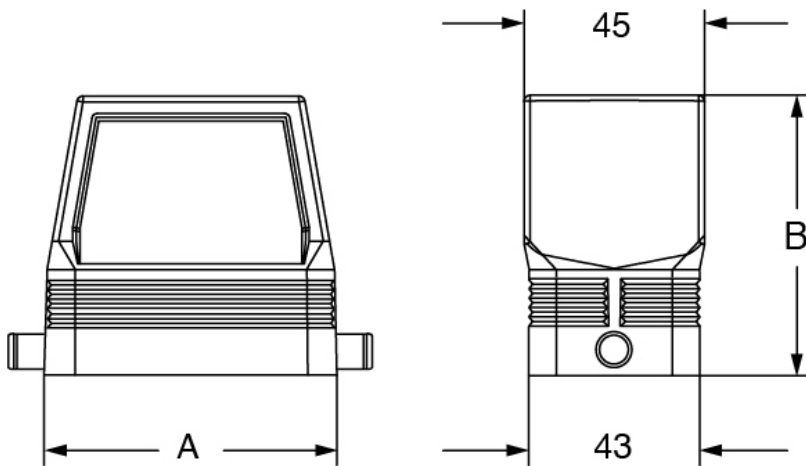

part No.	A	B
RAC 06 L	60	72
RAC 10 L	73	70
RAC 16 L	93,5	76
RAC 16 L	120	76