

Part number

# PK 6393 PB5



Interlocked switched socket-outlet, PK series,  
2 poles + PE, 9 h (red), 63 A, 380 ÷ 415 V,  
E33 - DIII fuse carrier

Product description		Material properties	
<b>Product type</b>	Interlocked switched socket-outlet	<b>Colour</b>	RAL 7035 grey, RAL 3000 red
<b>Series</b>	PK..PB5		Compliant with exemption 6(c): copper alloy containing up to 4% lead by weight
<b>N. of poles</b>	2 poles +	<b>RoHs conformity</b>	6(c): copper alloy containing up to 4% lead by weight
<b>Clock position</b>	9	<b>China RoHs - EFUP</b>	50
<b>Specification</b>	E33 - DIII fuse carrier	<b>REACH SVHC substances</b>	Yes Lead
Technical data		<b>SCIP number</b>	F6799547-ab84-42f2-938f-233ba663766d
<b>Current</b>	63 A	Approvals / Standards	
<b>Voltage</b>	380 ÷ 415 V	<b>Reference standard</b>	EN 60309-1, -2 e -4
<b>IP degree of protection</b>	IP55	General ordering information	
Further technical details		<b>EAN13 code</b>	8015747082921
<b>Weight</b>	3.400,00 g	Packaging Information	
<b>Operating temperature range (min, max)</b>	-25°C ... +40°C	<b>Packaging length</b>	400,00 mm
<b>IK rating (impact degree of protection)</b>	IK10	<b>Packaging height</b>	165,00 mm
		<b>Packaging width</b>	170,00 mm
		<b>Packaging weight</b>	4,00 kg
		<b>Packaging volume</b>	11,22 dm <sup>3</sup>
		<b>Packaging description</b>	Carton box
		<b>Packaging quantity</b>	1 Pcs
		<b>Packaging EAN code</b>	8015747082938

Part number

# PK 6393 PB5



## Catalogue drawings

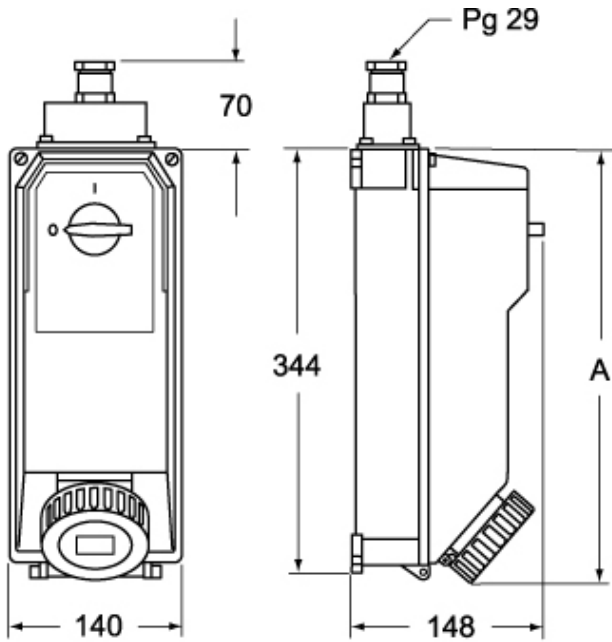

	<b>A</b>
<b>2P+⊕</b>	360
<b>3P+⊕</b>	360
<b>3P+N+⊕</b>	382