

Part number

PK 1693 PB5



Interlocked switched socket-outlet, PK series,
2 poles + PE, 9 h (red), 16 A, 380 ÷ 415 V,
E16 fuse carrier

Product description	
Product type	Interlocked switched socket-outlet
Series	PK..PB5
N. of poles	2 poles +
Clock position	9
Specification	E16 fuse carrier
Technical data	
Current	16 A
Voltage	380 ÷ 415 V
IP degree of protection	IP55
Further technical details	
Weight	1.657,00 g
Operating temperature range (min, max)	-25°C ... +40°C
IK rating (impact degree of protection)	IK10

Material properties	
Colour	RAL 7035 grey, RAL 3000 red
RoHs conformity	Compliant with exemption 6(c): copper alloy containing up to 4% lead by weight
China RoHs - EFUP	50
REACH SVHC substances	Yes Lead
SCIP number	Ce861c8d-b979-403b-96d9-80aef6dc281d
Approvals / Standards	
Reference standard	EN 60309-1, -2 e -4
General ordering information	
EAN13 code	8015747080668
Packaging Information	
Sub-packaging length	285,00 mm
Sub-packaging height	130,00 mm
Sub-packaging width	130,00 mm
Sub-packaging weight	1,66 kg
Sub-packaging volume	4,82 dm ³
Sub-packaging description	Carton box
Sub-packaging quantity	1 Pcs
Sub-packaging EAN barcode	8015747080675

Part number

PK 1693 PB5



Catalogue drawings

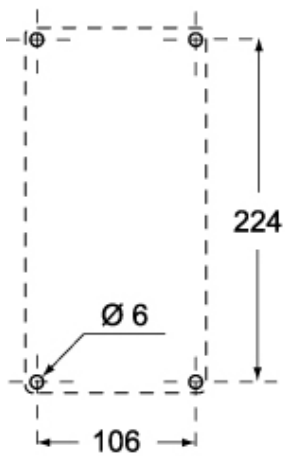
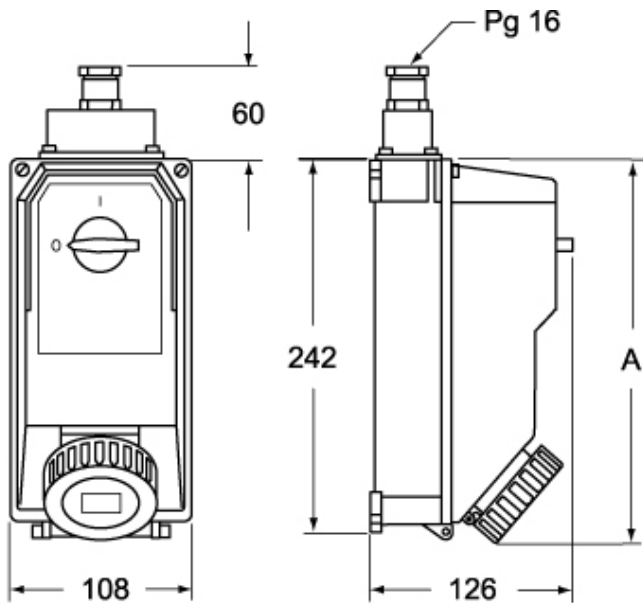

	A
2P+⊕	260
3P+⊕	260
3P+N+⊕	270