

Part number

# PK 1624 EB



Interlocked switched socket-outlet, PK series,  
3 poles + PE, 2 h (green), 16 A, > 50 V,  
without fuse-carrier

#### Product description

<b>Product type</b>	Interlocked switched socket-outlet
<b>Series</b>	PK..EB
<b>N. of poles</b>	3 poles + 
<b>Clock position</b>	2
<b>Specification</b>	Without fuse-carrier

#### Technical data

<b>Current</b>	16 A
<b>Voltage</b>	> 50 V
<b>IP degree of protection</b>	IP44

#### Further technical details

<b>Weight</b>	520,00 g
<b>Operating temperature range (min, max)</b>	-25°C ... +40°C
<b>IK rating (impact degree of protection)</b>	IK10

#### Material properties

<b>Colour</b>	RAL 7035 grey, RAL 6017 green
<b>RoHs conformity</b>	Compliant with exemption 6(c): copper alloy containing up to 4% lead by weight
<b>China RoHs - EFUP</b>	50
<b>REACH SVHC substances</b>	Yes Lead
<b>SCIP number</b>	Ce861c8d-b979-403b-96d9-80aef6dc281d

#### Approvals / Standards

<b>Reference standard</b>	EN 60309-1, -2 e -4
---------------------------	---------------------

#### General ordering information

<b>EAN13 code</b>	8015747079839
-------------------	---------------

#### Packaging Information

<b>Sub-packaging weight</b>	0,52 kg
<b>Sub-packaging description</b>	Carton box
<b>Sub-packaging quantity</b>	1 Pcs
<b>Sub-packaging EAN barcode</b>	8015747079846

Part number

# PK 1624 EB



Catalogue drawings

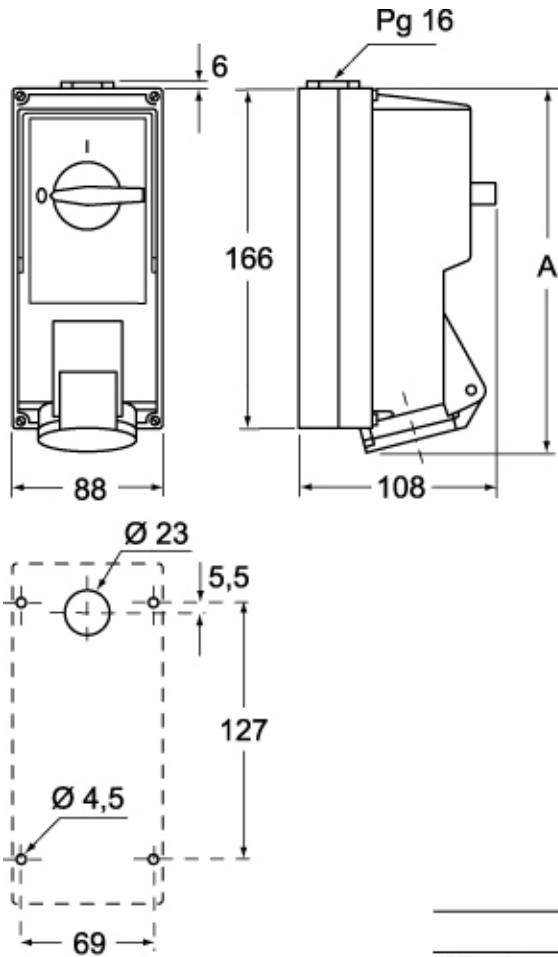

	<b>A</b>
<b>2P+⊕</b>	182
<b>3P+⊕</b>	182
<b>3P+N+⊕</b>	187