

Part number

# PEW 3264 PP



Wall-mounting socket outlet, PLUSO series, 3 poles + PE, 6 h (red), 32 A, 380 ÷ 415 V

Product description		Material properties	
<b>Product type</b>	Socket Wall-mounting	<b>Colour</b>	RAL 7035 grey, RAL 3000 red
<b>Series</b>	PEW...PP, PLUSO	<b>RoHs conformity</b>	Compliant with exemption 6(c): copper alloy containing up to 4% lead by weight
<b>N. of poles</b>	3 poles + 	<b>China RoHs - EFUP</b>	50
<b>Clock position</b>	6	<b>REACH SVHC substances</b>	Yes Lead
Technical data		<b>SCIP number</b>	Ca7de37f-add8-4b77-9861-279c94903ade
<b>Current</b>	32 A	Approvals / Standards	
<b>Voltage</b>	380 ÷ 415 V	<b>Reference standard</b>	EN 60309-1 and -2
<b>IP degree of protection</b>	IP67	General ordering information	
Further technical details		<b>EAN13 code</b>	8015747075404
<b>Weight</b>	475,00 g	Packaging Information	
<b>Operating temperature range (min, max)</b>	-25°C ... +40°C	<b>Packaging length</b>	440,00 mm
		<b>Packaging height</b>	180,00 mm
		<b>Packaging width</b>	330,00 mm
		<b>Packaging weight</b>	5,19 kg
		<b>Packaging volume</b>	26,14 dm <sup>3</sup>
		<b>Packaging description</b>	Carton box
		<b>Packaging quantity</b>	10 Pcs
		<b>Packaging EAN code</b>	8015747075411

Part number

# PEW 3264 PP



Catalogue drawings

( 16 / 32A) PEW ... PP

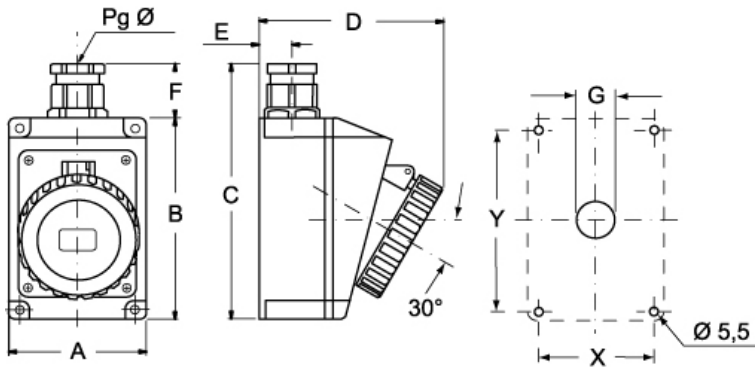

PEW ... PP	A	B	C	D	E	F	G	X	Y	Pg Ø
<b>16A</b> 2P+⊕	75	115	150	105	19	33	Ø22	65	105	16
3P+⊕	75	115	150	108	19	33	Ø22	65	105	16
3P+N+⊕	100	130	172	120	22	33	Ø22	85	115	21
<b>32A</b> 2P+⊕	100	130	172	120	22	42	Ø28	85	115	21
3P+⊕	100	130	172	120	22	42	Ø28	85	115	21
3P+N+⊕	100	130	172	120	22	42	Ø28	85	115	21