

Part number

PE 1693 PIF



Flush-mounting socket outlet, PLUSO series, 2 poles + PE, 9 h (red), 16 A, 380 ÷ 415 V, inclined, with bigger flange

Product description		Material properties	
Product type	Socket Flush-mounting	Colour	RAL 7035 grey, RAL 3000 red
Series	PE...PIF, PLUSO	RoHs conformity	Compliant with exemption 6(c): copper alloy containing up to 4% lead by weight
N. of poles	2 poles + 	China RoHs - EFUP	50
Clock position	9	REACH SVHC substances	Yes Lead
Size	Socket fixing centre distance 77 x 85 mm	SCIP number	Ca7de37f-add8-4b77-9861-279c94903ade
Specification	Inclined, bigger flange	Approvals / Standards	
Technical data		Reference standard	EN 60309-1 and -2
Current	16 A	General ordering information	
Voltage	380 ÷ 415 V	EAN13 code	8015747065320
IP degree of protection	IP44	Packaging Information	
Further technical details		Packaging length	285,00 mm
Weight	135,00 g	Packaging height	170,00 mm
Operating temperature range (min, max)	-25°C ... +40°C	Packaging width	190,00 mm
		Packaging weight	1,45 kg
		Packaging volume	9,21 dm ³
		Packaging description	Carton box
		Packaging quantity	10 Pcs
		Packaging EAN code	8015747065337

Part number

PE 1693 PIF



Catalogue drawings

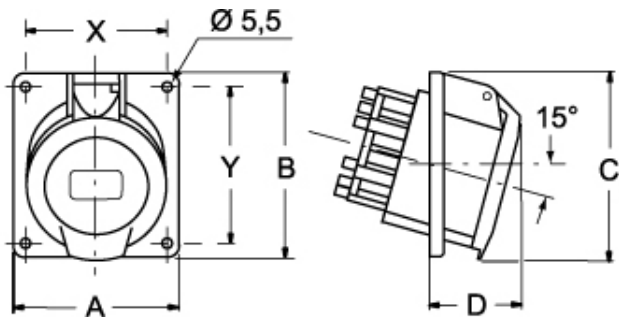

			A	B	C	D	X	Y
PIF	16 A	2P+⊕	92	100	--	52	77	85
		3P+⊕	92	100	--	53	77	85
PI	16 A	2P+⊕	64	82	--	38	52	60
		3P+⊕	64	82	--	42	52	60
		3P+N+⊕	92	100	--	43	77	60
PI	32 A	2P+⊕	92	100	--	40	77	85
		3P+⊕	92	100	--	40	77	85
		3P+N+⊕	92	102	--	43	77	85