

Part number

PE 1644 SI



Flush-mounting plug, PLUSO series, 3 poles + PE, 4 h (yellow), 16 A, 100 ÷ 130 V

Product description		Material properties	
Product type	Plug Flush-mounting	Colour	RAL 7035 grey, RAL 1021 yellow
Series	PE...SI, PLUSO	RoHs conformity	Compliant with exemption 6(c): copper alloy containing up to 4% lead by weight
N. of poles	3 poles +	China RoHs - EFUP	50
Clock position	4	REACH SVHC substances	Yes Lead
Size	Fixing centre distance socket 52 x 60 mm	SCIP number	Ca7de37f-add8-4b77-9861-279c94903ade
Technical data		Approvals / Standards	
Current	16 A	Reference standard	EN 60309-1 and -2
Voltage	100 ÷ 130 V	General ordering information	
IP degree of protection	IP44	EAN13 code	8015747064040
Further technical details		Packaging Information	
Weight	135,00 g	Packaging length	208,00 mm
Operating temperature range (min, max)	-25°C ... +40°C	Packaging height	140,00 mm
		Packaging width	290,00 mm
		Packaging weight	1,50 kg
		Packaging volume	8,44 dm ³
		Packaging description	Carton box
		Packaging quantity	10 Pcs
		Packaging EAN code	8015747064057

Part number

PE 1644 SI



Catalogue drawings

(16 / 32A) PE ... SI

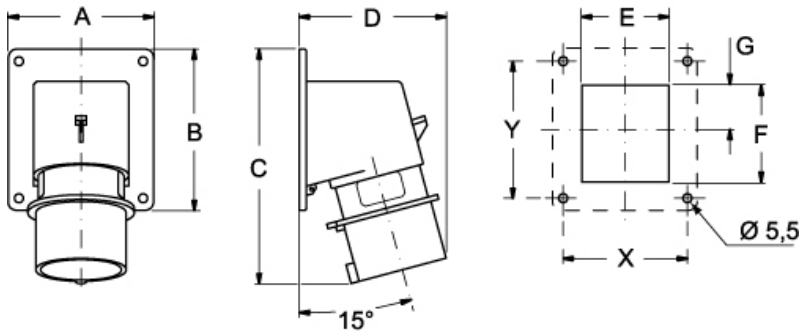

PE ... SI	A	B	C	D	E	F	G	X	Y
16A 2P+⊕	65	82	126	81	41	43	21,5	52	60
	65	82	126	81	47	43	21,5	52	60
	90	100	146	93	54	60	27,5	77	85
32A 2P+⊕	90	100	160	101	55	60	27,5	77	85
	90	100	160	101	55	60	27,5	77	85
	90	100	160	106	62	60	27,5	77	85