

Part number

MMV 16.40



Hood, 830V series, with 4 pegs, M40 top cable entry, size "104.27"

Product description		Material properties	
Product type	Hood	Colour	RAL 7040 grey
Series	830V	RoHs conformity	Compliant
Closing type	With 4 pegs	China RoHs - EFUP	E
Size	Size 104.27	REACH SVHC substances	No
Cable entry	Top cable entry M40	Approvals / Standards	
Technical data		Certifications	DNV, BV
IP degree of protection	IP65 / IP66 / IP69	UL	ECBT2
Further technical details		cUL	ECBT8
Weight	183,00 g	General ordering information	
Operating temperature range (min, max)	-40°C...+125°C	EAN13 code	8015747059084
		Packaging Information	
		Sub-packaging weight	0,92 kg
		Sub-packaging description	Plastic packaging
		Sub-packaging quantity	5 Pcs
		Sub-packaging EAN barcode	8015747108300

Part number

MMV 16.40



Catalogue drawings

**CMO [CMAO] CMV (CMAV) - MMO [MMAO]
MMV (MMAV)**

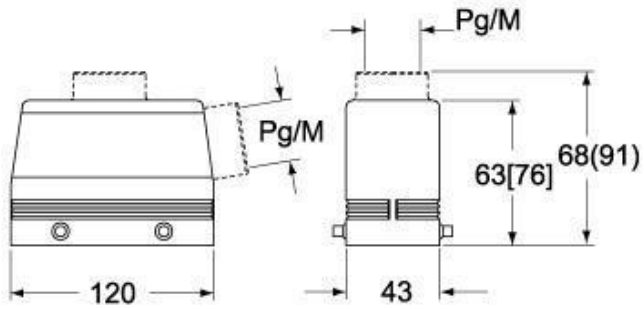

CMV G (CMAV G) - MMV G (MMAV G) - [MMFV G]

