

Part number

MMAP 16 CP40



Surface mounting housing, 830V series, with 4 pegs, M40 cable entry, size "104.27", high construction, with plastic cover

Product description		Material properties	
Product type	Surface mounting housing	Colour	RAL 7040 grey
Series	830V	RoHs conformity	Compliant
Closing type	With 4 pegs	China RoHs - EFUP	E
Size	Size 104.27	REACH SVHC substances	No
Cable entry	With cable entry M40	Approvals / Standards	
Specification	High construction, with plastic cover	Certifications	DNV, BV
Technical data		UL	ECBT2
IP degree of protection	IP65	cUL	ECBT8
Further technical details		General ordering information	
Operating temperature range (min, max)	-40°C...+125°C	EAN13 code	8015747057684
		Packaging Information	
		Sub-packaging description	Plastic packaging
		Sub-packaging quantity	5 Pcs
		Sub-packaging EAN barcode	8015747106528

Part number



MMAP 16 CP40

Catalogue drawings

CMP CMAP - MMP MMAP

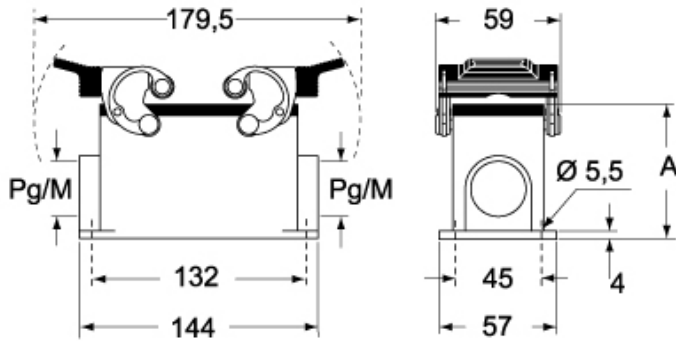

CMP CS/CP CMAP CS/CP - MMP CS/CP MMAP CS/CP

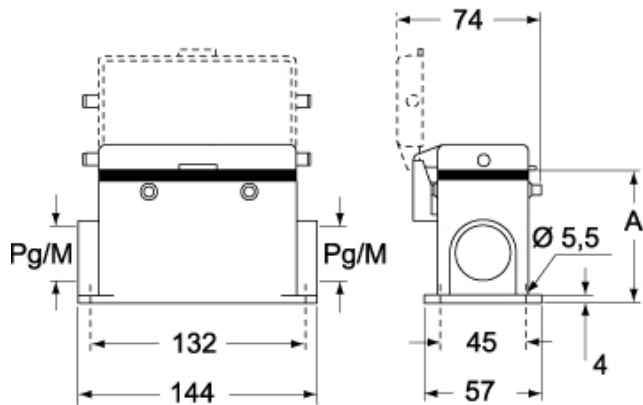

	A
CMP / MMP	63
CMAP / MMAP	80
CMP CS / MMP CS	63
CMAP CS / MMAP CS	80
CMP CP / MMP CP	63
CMAP CP / MMAP CP	80