

Part number

# MMAP 03 L240



Surface mounting housing, 830V series, with 1 lever, M40 x 2 cable entry, size "57.27", high construction

#### Product description

<b>Product type</b>	Surface mounting housing
<b>Series</b>	830V
<b>Closing type</b>	With 1 lever
<b>Size</b>	Size 57.27
<b>Cable entry</b>	With cable entry M40 x 2
<b>Specification</b>	High construction

#### Technical data

**IP degree of protection** IP65 / IP66 / IP69

#### Further technical details

<b>Weight</b>	275,00 g
<b>Operating temperature range (min, max)</b>	-40°C...+125°C

#### Material properties

<b>Colour</b>	RAL 7040 grey
<b>RoHs conformity</b>	Compliant
<b>China RoHs - EFUP</b>	E
<b>REACH SVHC substances</b>	No

#### Approvals / Standards

<b>Certifications</b>	DNV, BV
<b>UL</b>	ECBT2
<b>cUL</b>	ECBT8

#### General ordering information

**EAN13 code** 8015747057264

#### Packaging Information

<b>Sub-packaging weight</b>	1,38 kg
<b>Sub-packaging description</b>	Plastic packaging
<b>Sub-packaging quantity</b>	5 Pcs
<b>Sub-packaging EAN barcode</b>	8015747106252

Part number

# MMAP 03 L240



Catalogue drawings

## CMP L CMAP L - MMP L MMAP L

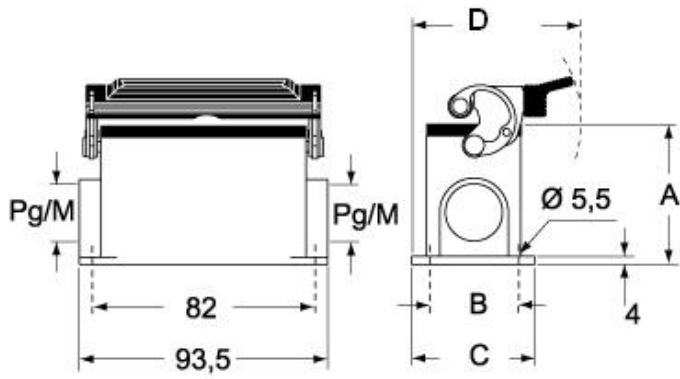

## CMP LS CMAP LS - MMP LS MMAP LS

