

Part number

MHP 50 CS32



Surface mounting housing, C-TYPE series, with 4 pegs, M32 cable entry, size "66.40", with metal cover

Product description

Product type	Surface mounting housing
Series	C-TYPE
Closing type	With 4 pegs
Size	Size "66.40"
Cable entry	With cable entry M32
Specification	With metal cover

Technical data

IP degree of protection IP65

Further technical details

Weight	460,00 g
Operating temperature range (min, max)	-40°C...+125°C

Material properties

Other materials	Gasket: NBR
Colour	RAL 7040 grey
RoHs conformity	Compliant
China RoHs - EFUP	E
REACH SVHC substances	No

Approvals / Standards

Certifications	DNV, BV
UL	ECBT2
cUL	ECBT8

General ordering information

EAN13 code	8015747055215
eCl@ss 8.1	27440202
ETIM 7.0	EC000437

Packaging Information

Sub-packaging length	175,00 mm
Sub-packaging height	100,00 mm
Sub-packaging width	235,00 mm
Sub-packaging weight	2,30 kg
Sub-packaging volume	4,11 dm ³
Sub-packaging description	Carton box
Sub-packaging quantity	5 Pcs
Sub-packaging EAN barcode	8015747098991

Part number

MHP 50 CS32



Catalogue drawings

CHP - MHP

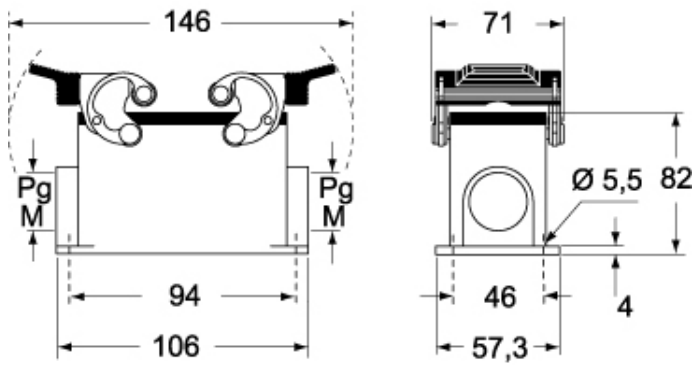

CHP CS - MHP CS

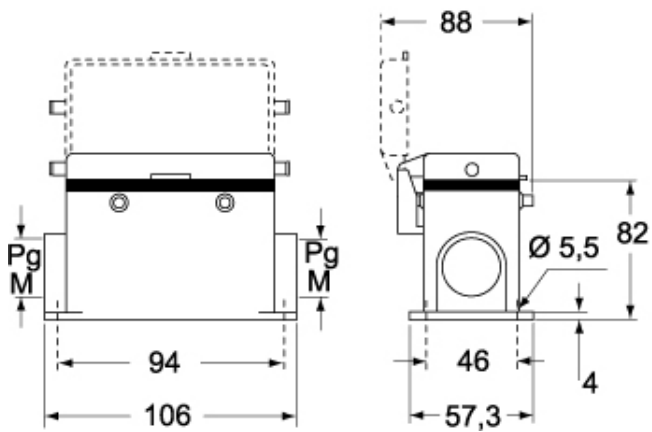

Catalogue drawings

