

Part number

MGV 24.32 B



Hood, IP68 series, with 2 bayonets, M32 top cable entry, size "104.27"

Product description

Product type	Hood
Series	IP68
Closing type	With 2 bayonets
Size	Size 104.27
Cable entry	Top cable entry M32

Technical data

IP degree of protection IP66 / IP68 / IP69

Further technical details

Weight	560,50 g
Operating temperature range (min, max)	-40°C...+125°C

Material properties

Main material	Aluminium die-cast
Other materials	Bayonet: Stainless steel
Colour	RAL 9005 black
RoHs conformity	Compliant
China RoHs - EFUP	E
REACH SVHC substances	No

Approvals / Standards

Certifications	DNV, BV
UL	ECBT2
cUL	ECBT8

General ordering information

EAN13 code	8015747124201
eCl@ss 8.1	27440202
ETIM 7.0	EC000437

Packaging Information

Packaging length	205,00 mm
Packaging height	135,00 mm
Packaging width	135,00 mm
Packaging weight	1,22 kg
Packaging volume	3,74 dm ³
Packaging description	Carton box
Packaging quantity	2 Pcs
Packaging EAN code	8015747124638
Sub-packaging weight	0,61 kg
Sub-packaging description	Plastic packaging
Sub-packaging quantity	1 Pcs
Sub-packaging EAN barcode	8015747124645

Part number

MGV 24.32 B



Catalogue drawings

CGO/MGO..B CGV/MGV..B

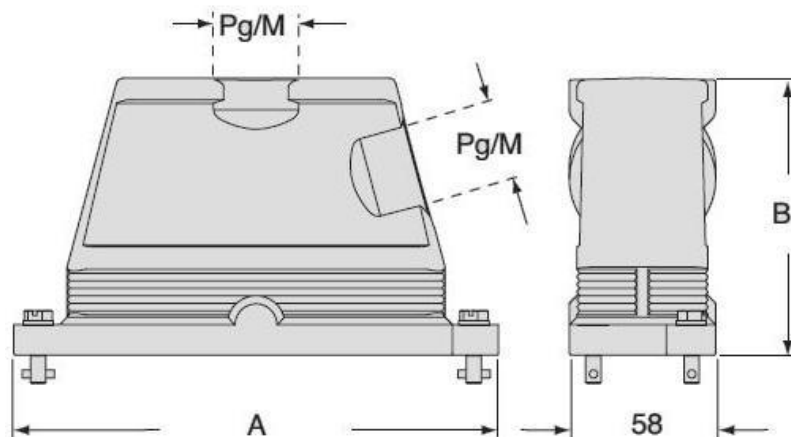

		A	B
CGO/MGO	CGV/MGV 06 B	133	101
CGO/MGO	CGV/MGV 10 B	146	101
CGO/MGO	CGV/MGV 16 B	166	111
CGO/MGO	CGV/MGV 24 B	193	111