

Part number

MFV 48 L50



Hood, C-TYPE series, with 2 pegs, M50 top cable entry without adapter, size "104.62"

Product description		Material properties	
Product type	Hood	Colour	RAL 7040 grey
Series	C-TYPE	RoHs conformity	Compliant
Closing type	With 2 pegs	China RoHs - EFUP	E
Size	Size 104.62	REACH SVHC substances	No
Cable entry	Top cable entry M50	Approvals / Standards	
Technical data		Certifications	DNV, BV
IP degree of protection	IP65 / IP66 / IP69	UL	ECBT2
Further technical details		cUL	ECBT8
Weight	533,00 g	General ordering information	
Operating temperature range (min, max)	-40°C...+125°C	EAN13 code	8015747101486
		eCl@ss 8.1	27440202
		ETIM 7.0	EC000437
		Packaging Information	
		Packaging length	190,00 mm
		Packaging height	140,00 mm
		Packaging width	290,00 mm
		Packaging weight	2,36 kg
		Packaging volume	7,71 dm ³
		Packaging description	Carton box
		Packaging quantity	4 Pcs
		Packaging EAN code	8015747101769
		Sub-packaging weight	0,59 kg
		Sub-packaging description	Plastic packaging
		Sub-packaging quantity	1 Pcs
		Sub-packaging EAN barcode	8015747101776

Part number

MFV 48 L50



Catalogue drawings

CHO L - MHO L - MFO L

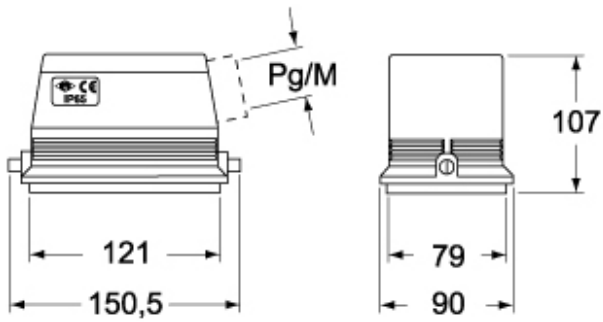

CHV L - MHV L - MFV L

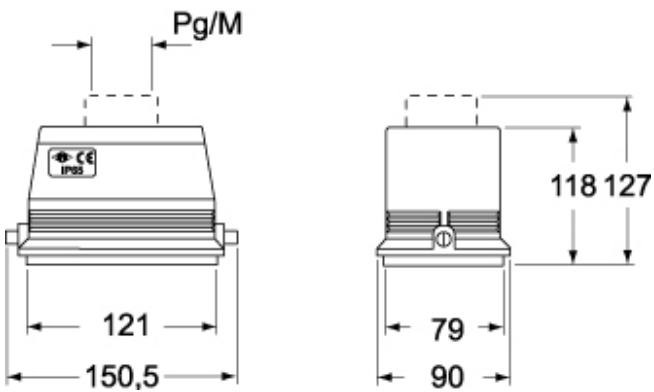

Catalogue drawings

