

Part number

# MFV 32.32



Hood, C-TYPE series, with 4 pegs, M32 top cable entry without adapter, size "77.62"

#### Product description

<b>Product type</b>	Hood
<b>Series</b>	C-TYPE
<b>Closing type</b>	With 4 pegs
<b>Size</b>	Size 77.62
<b>Cable entry</b>	Top cable entry M32

#### Technical data

<b>IP degree of protection</b>	IP65 / IP66 / IP69
--------------------------------	--------------------

#### Further technical details

<b>Weight</b>	378,00 g
<b>Operating temperature range (min, max)</b>	-40°C...+125°C

#### Material properties

<b>Colour</b>	RAL 7040 grey
<b>RoHs conformity</b>	Compliant
<b>China RoHs - EFUP</b>	E
<b>REACH SVHC substances</b>	No

#### Approvals / Standards

<b>Certifications</b>	DNV, BV
<b>UL</b>	ECBT2
<b>cUL</b>	ECBT8

#### General ordering information

<b>EAN13 code</b>	8015747152273
<b>eCl@ss 8.1</b>	27440202
<b>ETIM 7.0</b>	EC000437

#### Packaging Information

<b>Packaging length</b>	255,00 mm
<b>Packaging height</b>	195,00 mm
<b>Packaging width</b>	245,00 mm
<b>Packaging weight</b>	4,02 kg
<b>Packaging volume</b>	12,18 dm <sup>3</sup>
<b>Packaging description</b>	Carton box
<b>Packaging quantity</b>	8 Pcs
<b>Packaging EAN code</b>	8015747200240
<b>Sub-packaging weight</b>	0,50 kg
<b>Sub-packaging description</b>	Plastic packaging
<b>Sub-packaging quantity</b>	1 Pcs
<b>Sub-packaging EAN barcode</b>	8015747200257

Part number

# MFV 32.32



Catalogue drawings

**CHO - CHV MHO/MFO/MFV - MHV  
MMV (MMAV)**

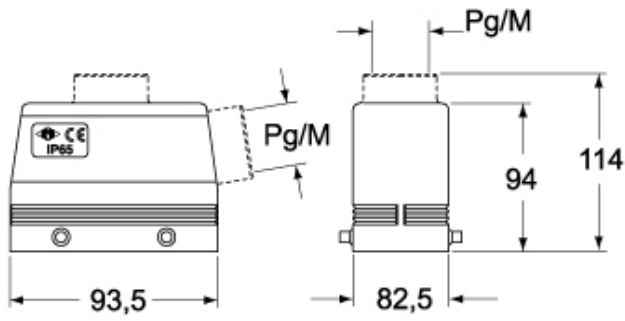

**CHV G - MHV G - MFV G**

