

Part number

# MFV 32 G40



Hood, C-TYPE series, with 2 levers, M40 top cable entry without adapter, size "77.62"

#### Product description

<b>Product type</b>	Hood
<b>Series</b>	C-TYPE
<b>Closing type</b>	With 2 levers
<b>Size</b>	Size 77.62
<b>Cable entry</b>	Top cable entry M40

#### Technical data

**IP degree of protection** IP65 / IP66 / IP69

#### Further technical details

<b>Weight</b>	468,00 g
<b>Operating temperature range (min, max)</b>	-40°C...+125°C

#### Material properties

<b>Other materials</b>	Lever: Stainless steel, polyamide (PA) Gasket: NBR
<b>Colour</b>	RAL 7040 grey
<b>RoHs conformity</b>	Compliant
<b>China RoHs - EFUP</b>	E
<b>REACH SVHC substances</b>	No

#### Approvals / Standards

<b>Certifications</b>	DNV, BV
<b>UL</b>	ECBT2
<b>cUL</b>	ECBT8

#### General ordering information

<b>EAN13 code</b>	8015747152228
<b>eCl@ss 8.1</b>	27440202
<b>ETIM 7.0</b>	EC000437

#### Packaging Information

<b>Sub-packaging weight</b>	0,47 kg
<b>Sub-packaging description</b>	Plastic packaging
<b>Sub-packaging quantity</b>	1 Pcs
<b>Sub-packaging EAN barcode</b>	8015747232340

Part number

# MFV 32 G40



Catalogue drawings

**CHO - CHV MHO/MFO/MFV - MHV  
MMV (MMAV)**

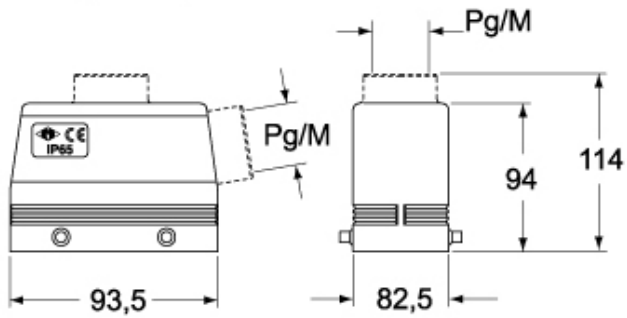

**CHV G - MHV G - MFV G**

